

Smart⁴⁴ Touch⁴⁴



44PSMTC3GTK Gris TEKLA Effet mat

44PSMTC3AA Acier anthracite Effet brossé

44PSMTC3AS Acier naturel Effet brossé

44PSMTC3B Blanc Effet brillant

44PSMTC3TO Taupe Effet mat

Toutes les plaques SMART TOUCH existent en : 3 modules : Jusqu'à 6 commandes
: 4 modules : Jusqu'à 7 commandes

Smart⁴⁴



44PSM3GTK Gris TEKLA Effet mat

44PSM3AA Acier anthracite Effet brossé

44PSM3AS Acier naturel Effet brossé

44PSM3B Blanc Effet brillant

44PSM3TO Taupe Effet mat

Toutes les plaques SMART existent en 3, 4 et 7 modules

Les prises coulissantes

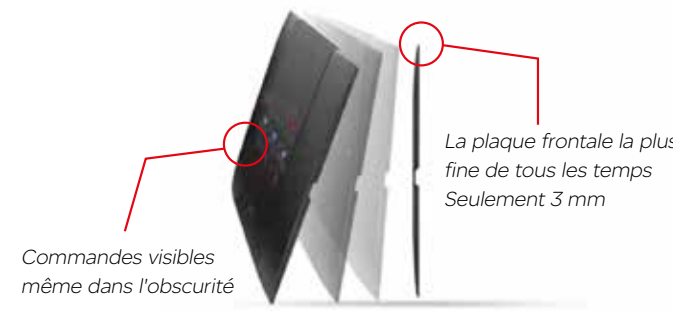

Plaques frontale SMART TOUCH



Plaques frontales SMART

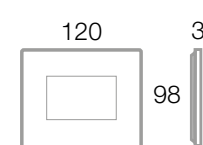

CUBICA



Tailles des plaques

Toutes les plaques CUBICA existent en :
Carrée : 2, 2+2 et 2+2+2 modules

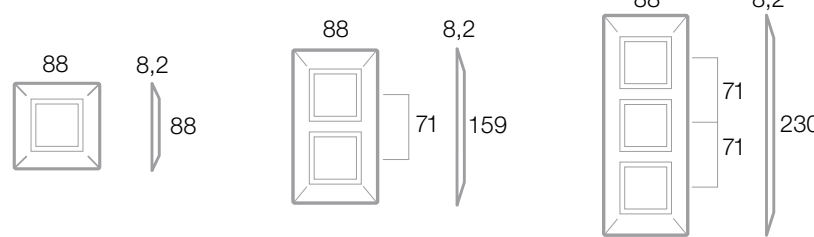

TECHNOPOLYMÈRE



Toutes les plaques TECHNOPOLYMÈRE existent en :
- Carrée : 2, 2+2 et 2+2+2 modules
2+2+2 existe seulement en B
- Rectangulaire : 3 modules : 1, 2 et 3 commandes
4 et 7 modules
- 3+3 seulement en B
- 6+6 seulement en B et AO

ZAMA



Toutes les plaques ZAMA existent en : Carrée : 2, 2+2 et 2+2+2 modules
- Rectangulaire : 3, 4 et 7 modules
- 3+3 existe seulement en B, ALS, GSM et NAL

Tailles des plaques

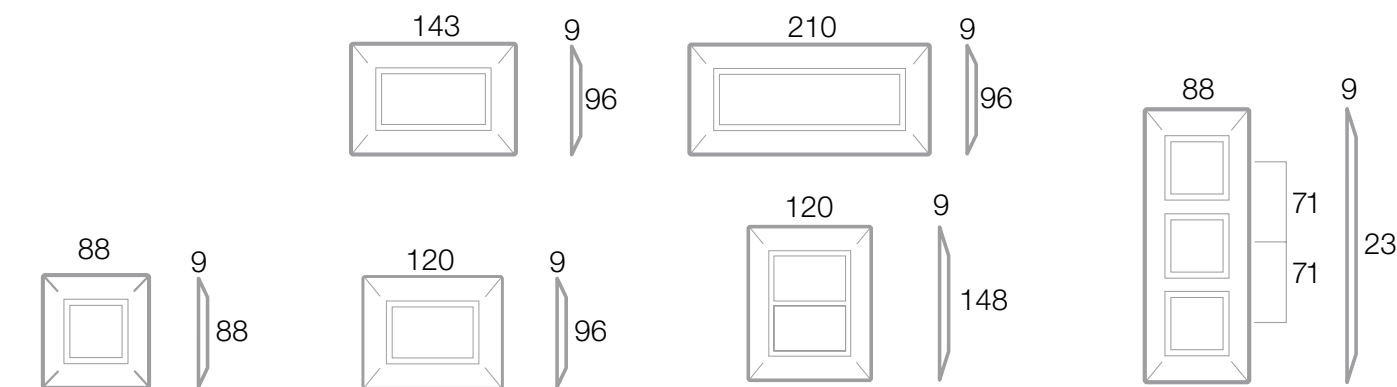

Cadres interchangeables



CRK - View Concept 151 93 300

DP-SYS44-01-2024



Appareillages Electriques

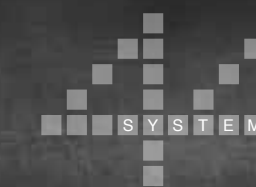

Siège Tunis : Rue des Usines Z.I. Sidi Rezig - 2033 Megrine - Tunis - TUNISIE
Tél.: (+216) 71 429 611 - (+216) 71 429 612 - Fax: (+216) 71 428 562 - Email : info@somef.tn

Showroom Soukra : Tél.: (+216) 56 837 444 - Email : showroom.tunis@somef.tn

Showroom Sfax : Tél.: (+216) 56 837 454 - Email : showroom.sfax@somef.tn

Showroom Sousse : Tél.: (+216) 51 388 737 - Email : showroom.sousse@somef.tn



www.somef.tn

VERA Rectangulaire

Les prises coulissantes

ALUMINIUM



44PATC3ALS Aluminium naturel brossé
44PATC3ANS Aluminium anthracite brossé
44PA3ALS Aluminium naturel brossé
44PA3ANS Aluminium anthracite brossé



44PATCS3ALS Aluminium naturel brossé
Existe en Aluminium anthracite brossé : 44PATCS3ANS

VERRE

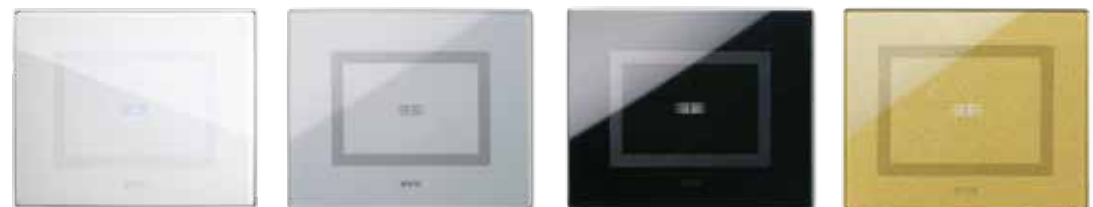

44PVT01BL Blanc clair
44PVT01GO Gris argent givré
44PVT01NAL Noir absolu
44PVT01GOLD Gold



44PVTCS3BL Blanc clair
Existe en BL, GO, NAL et GOLD
A utiliser avec un support disponible en

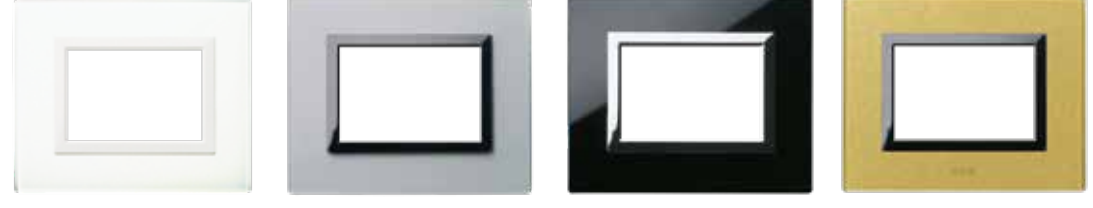

44PV3BL Blanc clair
44PV3GO Gris argent givré
44PV3NAL Noir absolu
44PV3GOLD Gold

Aluminium naturel : 44ATC03ALS
Gris : 44ATC03GSL
Blanc : 44ATC03B

Toutes les plaques VERA TOUCH Rectangulaires existent en : 3 modules 1, 2, 3 et 6 commandes
4 modules 3 et 4 commandes 7 modules 4 et 7 commandes
- 3+3 modules 6 commandes existent seulement en noir et en blanc.

Toutes les plaques VERA Rectangulaires existent en : 3, 4 et 7 modules.
- 3+3 existent seulement en noir et en blanc.



Tailles des plaques VERA TOUCH ALUMINIUM

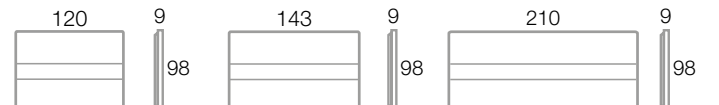

Tailles des plaques VERA TOUCH VERRE

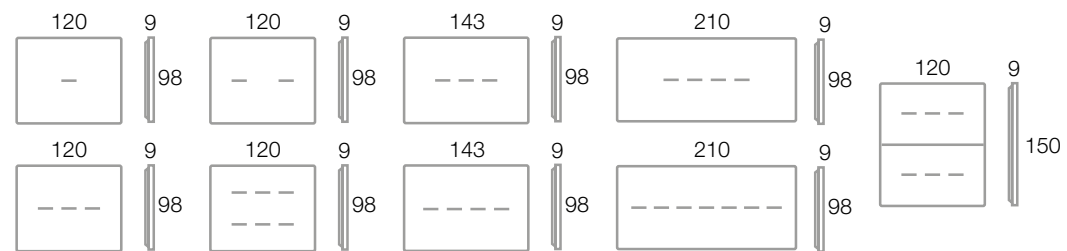

Tailles des plaques VERA ALUMINIUM



Tailles des plaques VERA VERRE

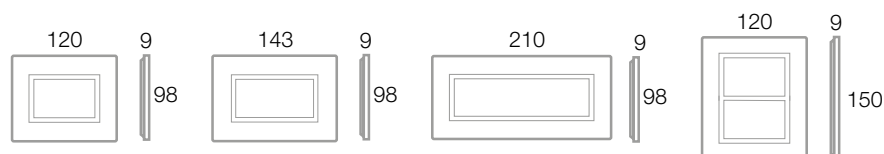

ALUMINIUM



44PATC22ALS Aluminium naturel brossé
44PATC22ANS Aluminium anthracite brossé
44PA22ALS Aluminium naturel brossé
44PA22ANS Aluminium anthracite brossé

VERRE



44PVT22BL Blanc clair
44PVT22GO Gris argent givré
44PVT22NAL Noir absolu
44PVT22GOLD Gold

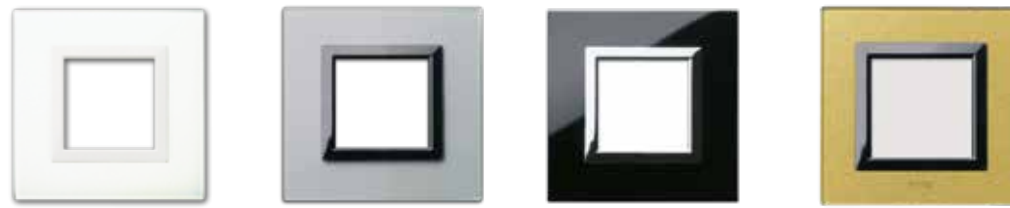

44PV22BL Blanc clair
44PV22GO Gris argent givré
44PV22NAL Noir absolu
44PV22GOLD Gold

Toutes les plaques VERA TOUCH Carrées existent en : 2 modules : 1 et 2 commandes

Toutes les plaques VERA Carrées existent en : 2 modules : 1 et 2 trous, 2+2, 2+2+2 et 2+2+2+2.

Tailles des plaques VERA TOUCH

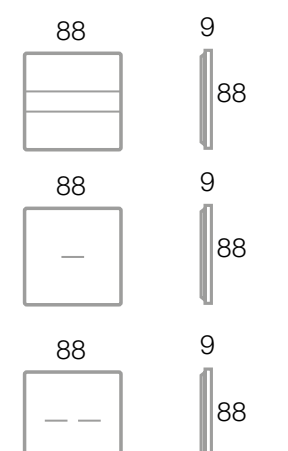

Tailles des plaques VERA

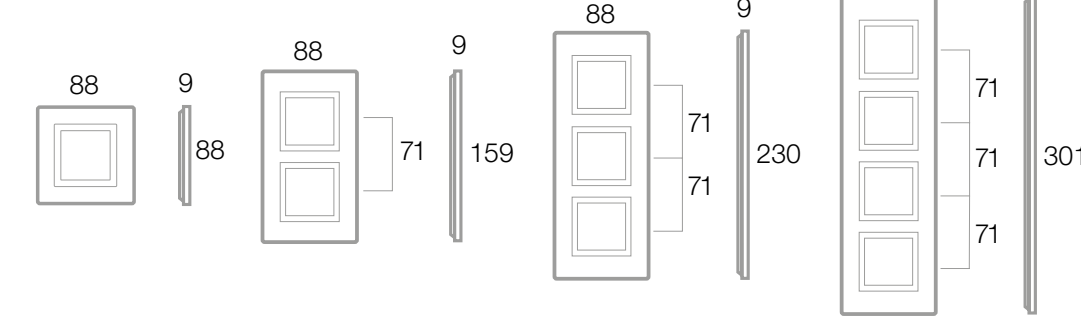

BOIS / CORIAN



44PL3RS Chêne 3, 4, 7 modules
44PL3WG Wengé 3,4,7 modules
44PCN3B Blanc 3,4,7 modules

YOUNG

YOUNG TOUCH



44PJTC3AVN Marron
44PJTC3AVR Ivoire
44PJTC3B Blanc
44PJTC3BT Blanc total



44PJTC3GM Gris métallisé
44PJTC3GOLD Doré
44PJTC3GSO Blanc craie
44PJTC3GTK Gris TEKLA



44PJTC3NAL Noir absolu
44PJTC3SA Sable
44PJTC3SAL Saugé
44PJTC3CNR Gris cendré



44PJTC3GTKT Gris anthracite
44PJTC3CBS/3D Charbon foncé 3D
44PJTC3B/3D Blanc 3D
44PJTC3BEG/3D Beige brossé 3D

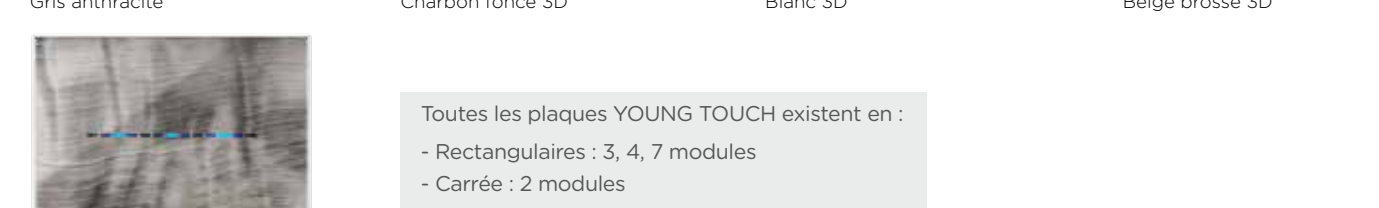

44PJTC3ONC/3D Onyx 3D
44PJ03BEG/3D Beige brossé 3D

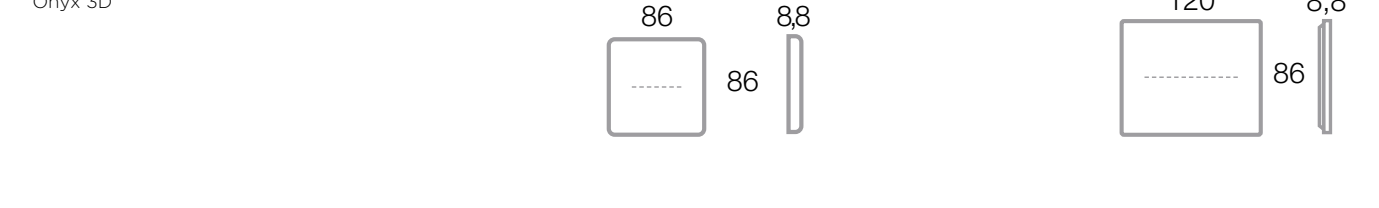

44PJ03ONC/3D Onyx 3D
44PJ03BEG/3D Beige brossé 3D

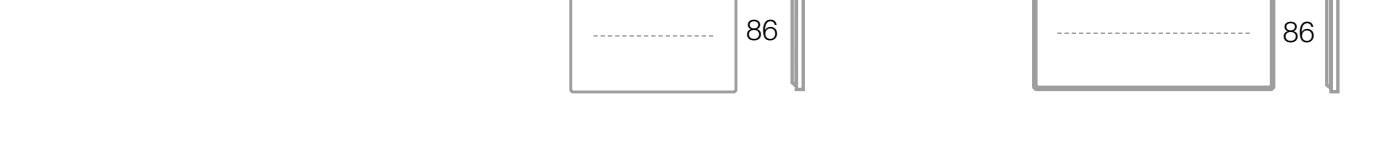

YOUNG



44PJ03AVN Marron
44PJ03AVR Ivoire
44PJ03B Blanc
44PJTC3BT Blanc total

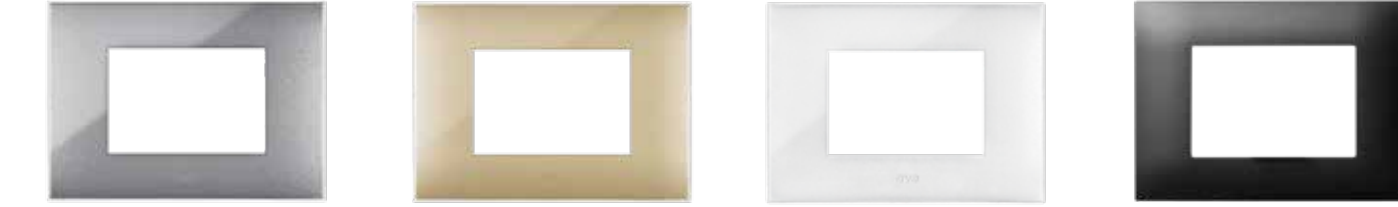

44PJ03GM Gris métallisé
44PJ03GOLD Doré
44PJ03GSO Blanc craie
44PJ03GTK Gris TEKLA



44PJ03NAL Noir absolu
44PJ03SA Sable
44PJ03SAL Saugé
44PJ03CNR Gris cendré

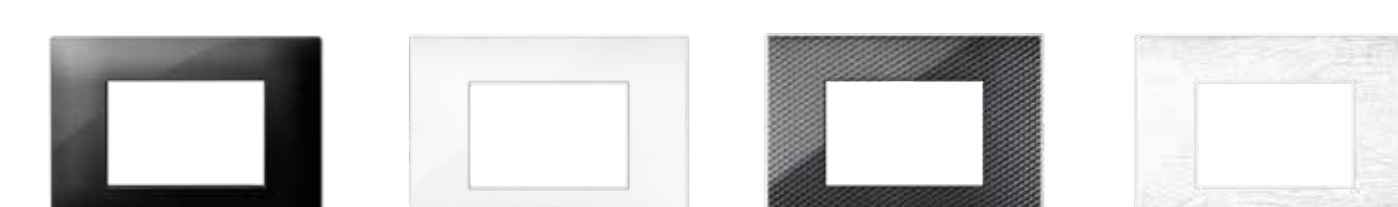

44PJ03GTKT Gris anthracite
44PJ03BO Blanc Matt
44PJ03CBS/3D Charbon foncé 3D
44PJ03B/3D Blanc 3D



44PJ03ONC/3D Onyx 3D
44PJ03BEG/3D Beige brossé 3D

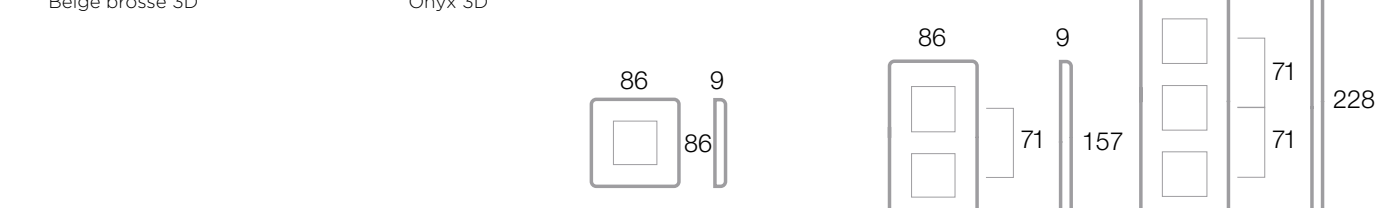

44PJ03ONC/3D Onyx 3D
44PJ03BEG/3D Beige brossé 3D

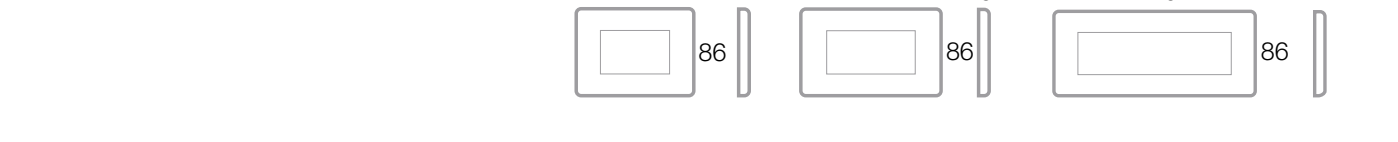

YOUNG

Toutes les plaques YOUNG existent en :
- Rectangulaire : 3, 4, 7 modules
- Carrée : 2, 2+2 et 2+2+2, 2+2+2+2 seulement en GTK et BT