

SOMEF



# 43 Système

*L'innovation au service  
de votre confort*



# Sommaire

## **Plaques de finition**

Plaques LUMINA .....	2
Plaques LUMINA 2D .....	6
Plaques LINA .....	8
Plaques LINA 2D .....	12
Plaques SERENA Rectangulaire .....	16
Plaques SERENA Carrée .....	25
Plaques BELLA .....	34
Plaques & Cadres .....	41

## **Gamme étanche**

Prises .....	42
Interrupteurs .....	43

## **Appareillages & Caractéristiques**

Appareillages Système 43 .....	45
<b>Générales</b> .....	46

<b>Commandes &amp; Accessoires</b> .....	62
--	----

<b>Boîtes Apparentes</b> .....	70
--------------------------------	----

Plaque  
**LUMINA**  
Système 43

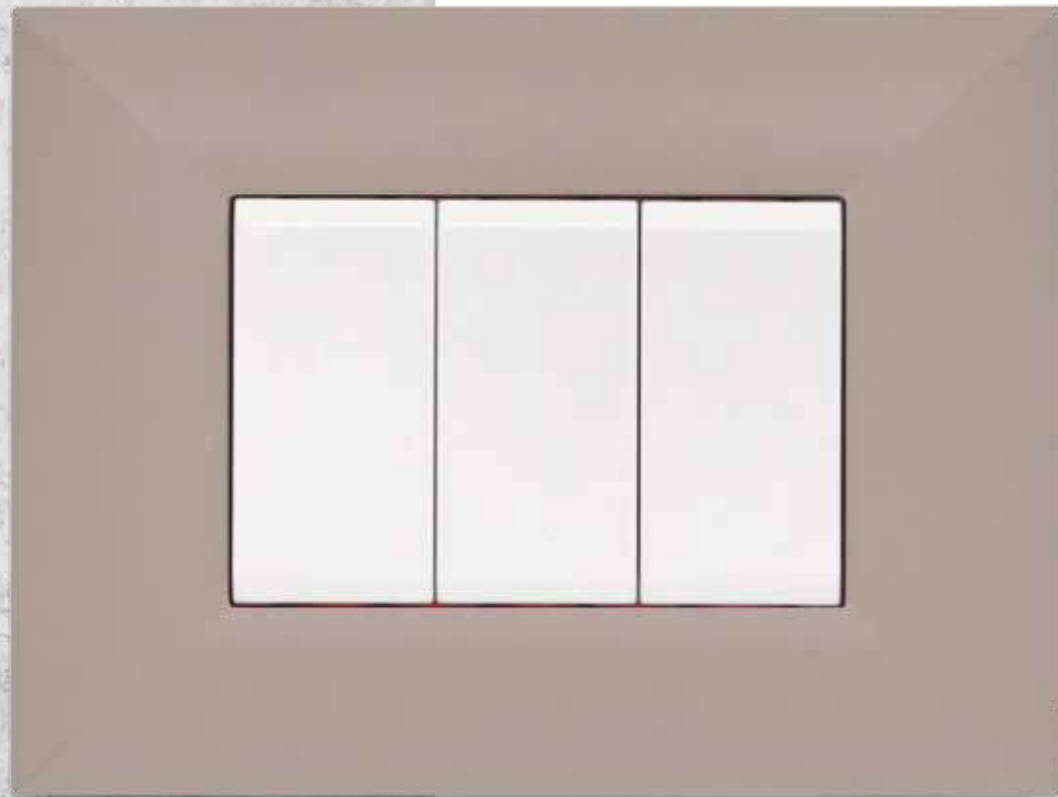

Le design moderne de la plaque Lumina met les lignes et les matières en valeur

Des teintes en harmonie avec les tendances contemporaines



*Plaques disponibles en 3, 4 et 7 modules.*



43PL03GRE  
Grège



43PL03ARG  
Argile



43PL03TNM  
Titanium



43PL03NR  
Noir Mat

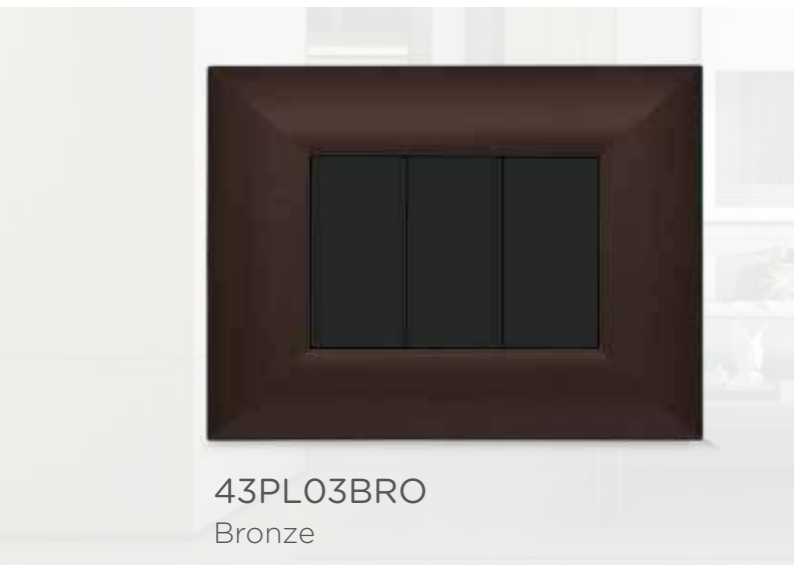

43PL03BRO  
Bronze



43PL03AO  
Argent Opaque



# LUMINA 2D

Une Matière brillante pour  
un effet glacé et très spécial

Quatre tons exclusifs  
pour embellir vos intérieurs

Plaque  
LUMINA 2D  
Système 43

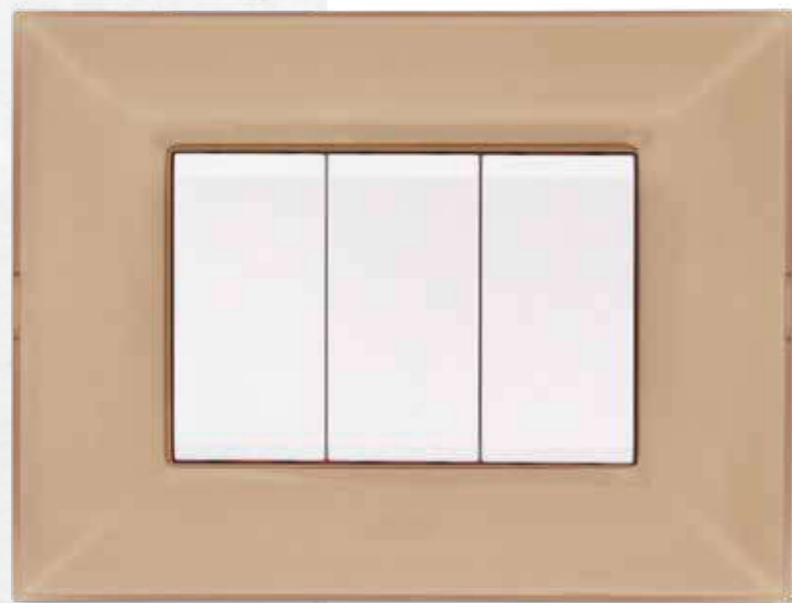

43PL03B  
Blanc



43PL03M  
Marron

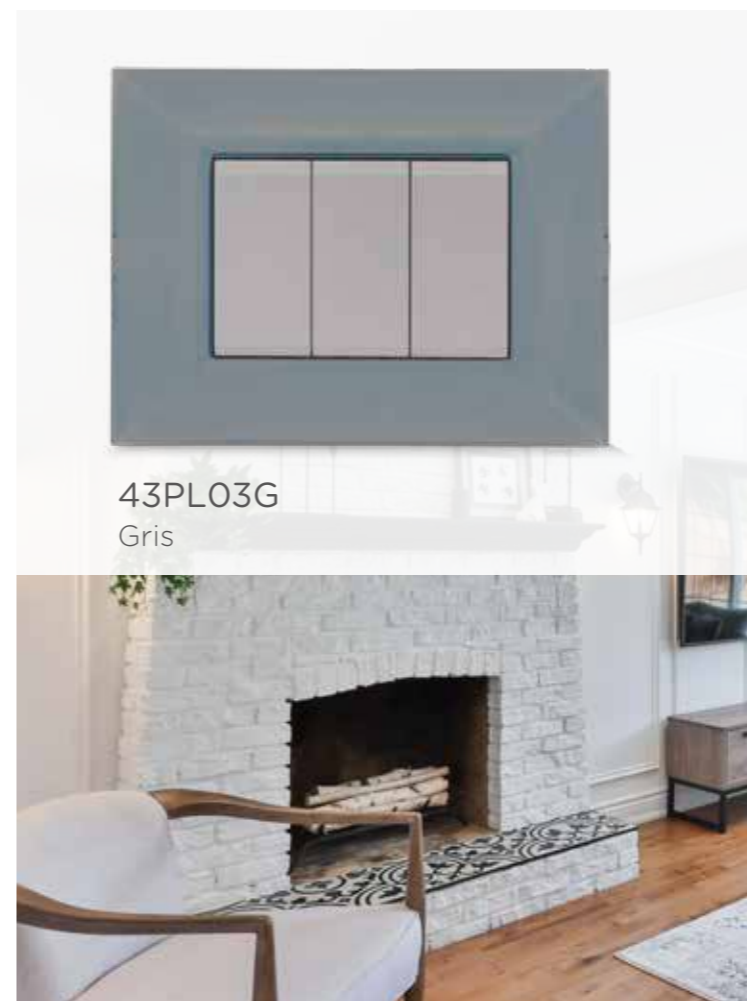

43PL03G  
Gris

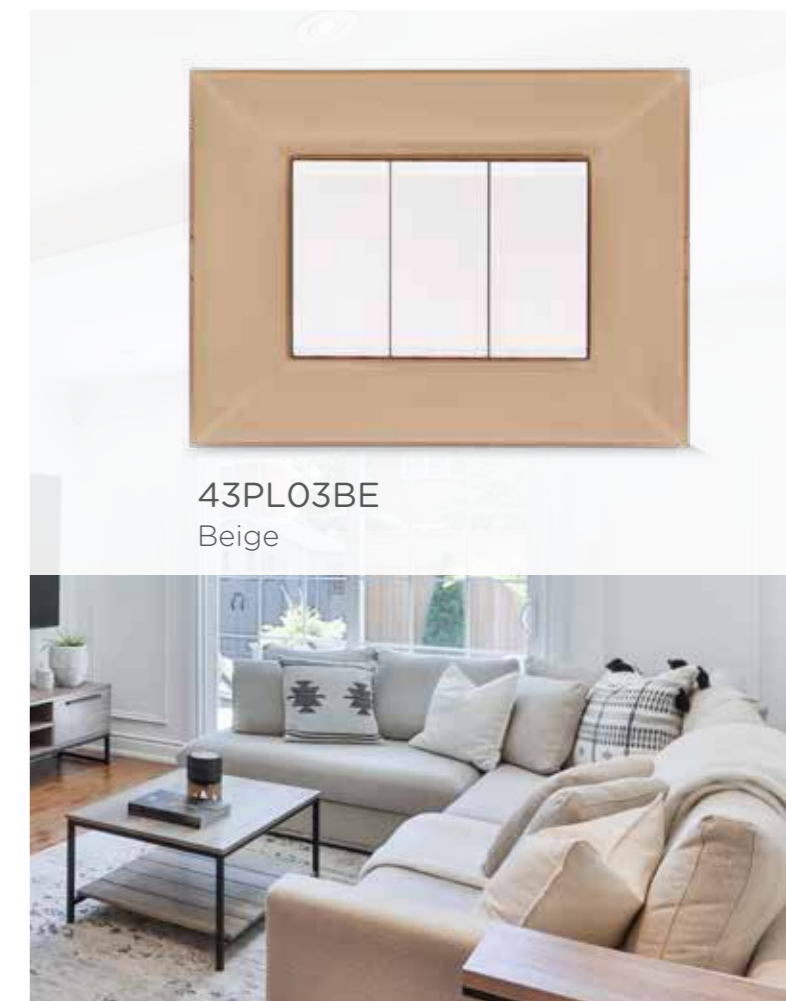

43PL03BE  
Beige

Plaque  
**LINA**  
Système **43**

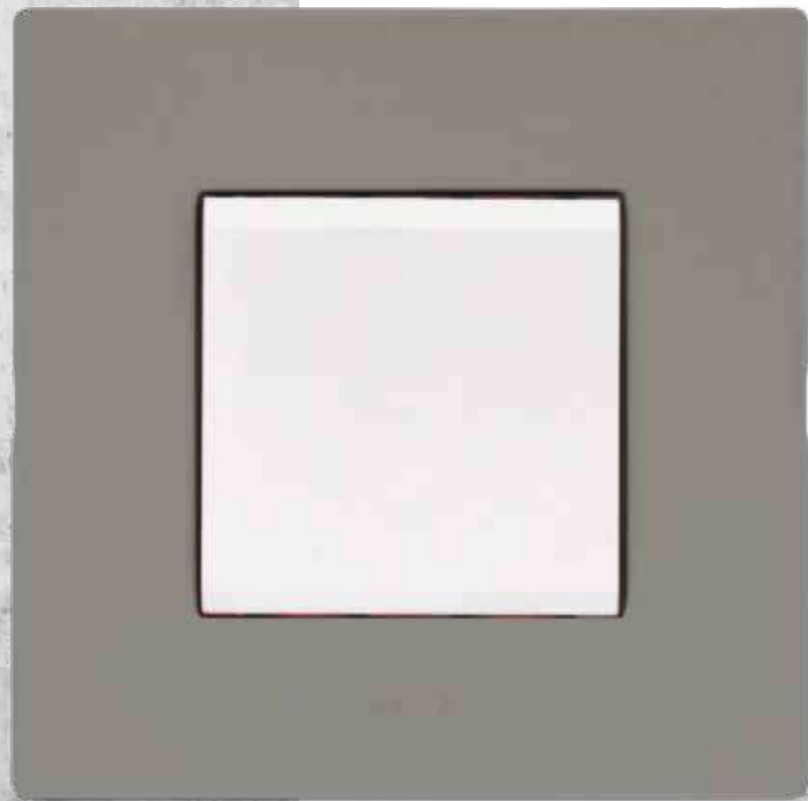

En version carrée,  
vous trouvez  
la Plaque Lina avec  
son design doux  
décliné en  
6 couleurs mates  
pour plus d'élégance  
et de sobriété



*Plaques disponibles en 2+2 et 2+2+2 modules.*



43PL32GRE  
Grège

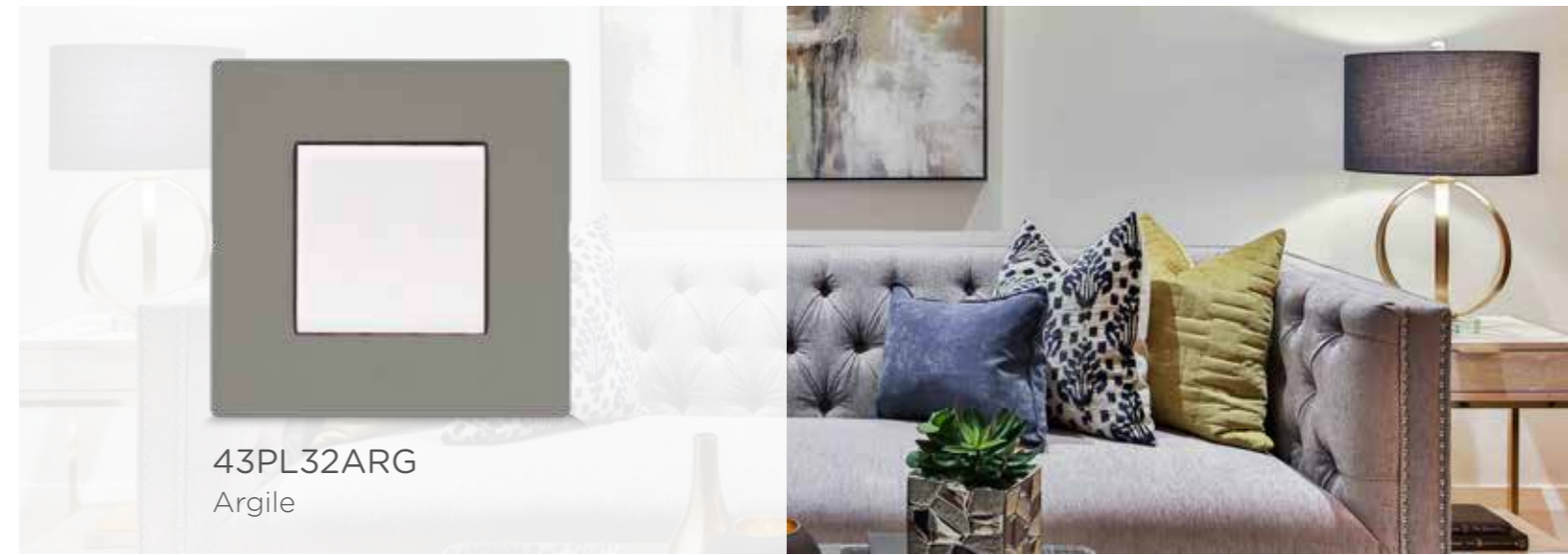

43PL32ARG  
Argile



43PL32TNM  
Titanium

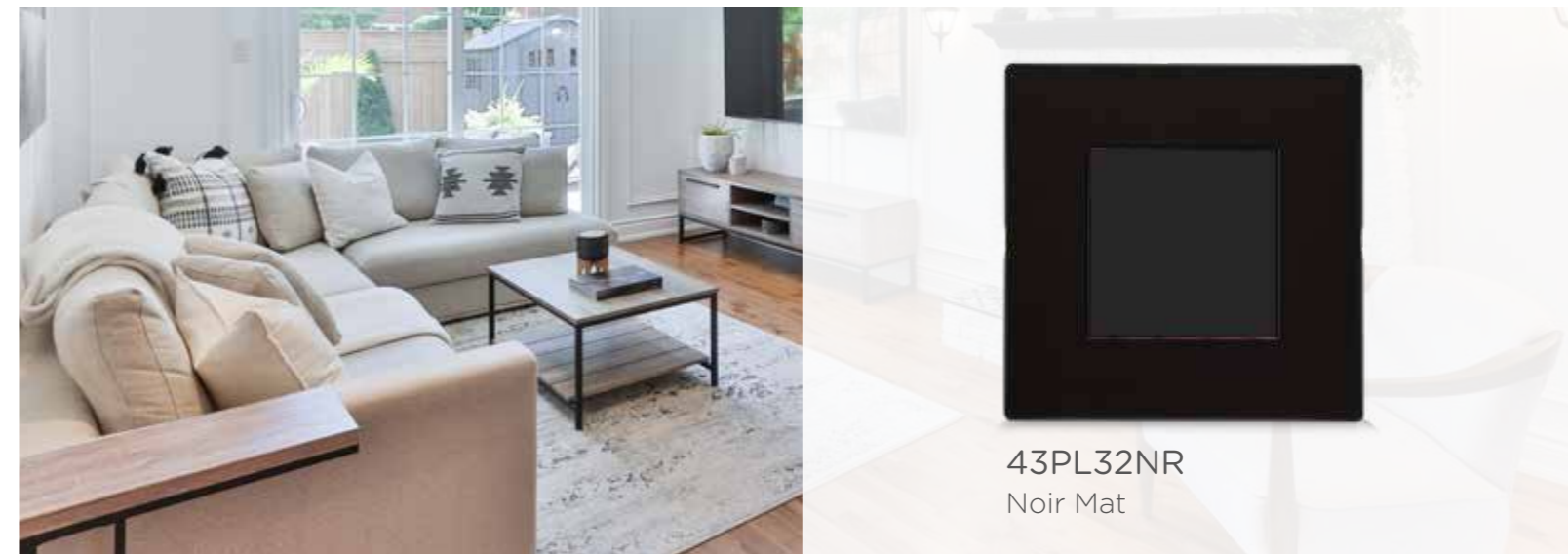

43PL32NR  
Noir Mat



43PL32BRO  
Bronze



43PL32AO  
Argent Opaque

# LINA 2D

Elle s'intègre parfaitement  
avec vos intérieurs pour donner  
une touche d'éclat à vos murs

Plaque  
LINA 2D  
Système 43



43PL32B  
Blanc

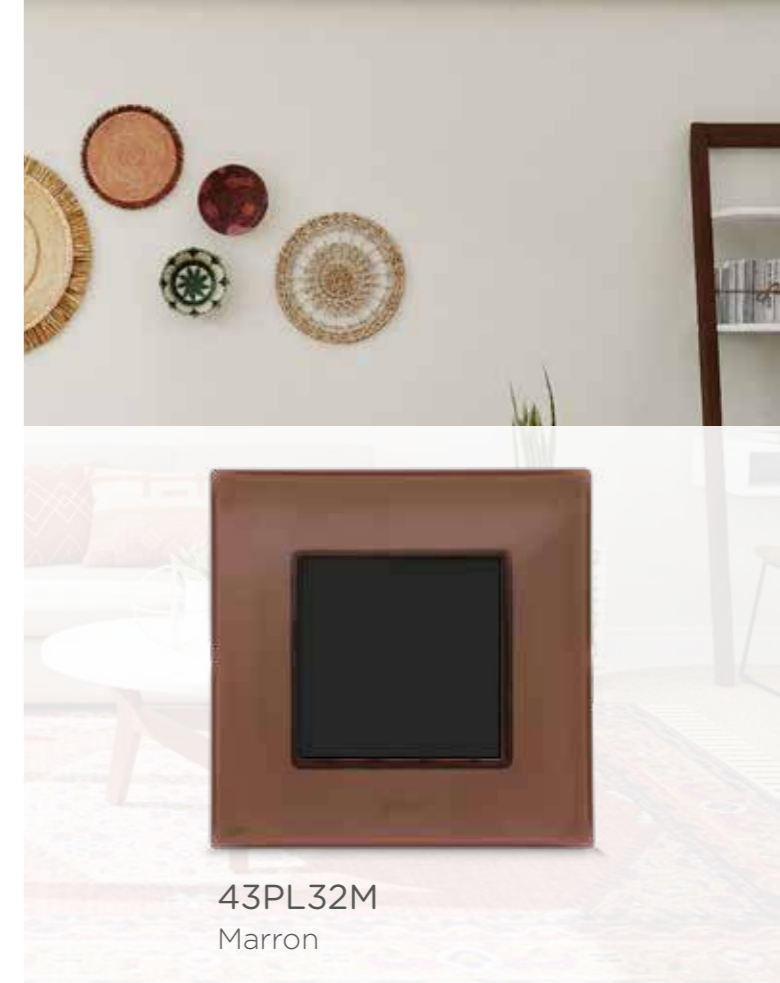

43PL32M  
Marron



43PL32G  
Gris



43PL32BE  
Beige





# LUMINA



43PLO3GRE  
Grège



43PLO3TNM  
Titanium



43PLO3BRO  
Bronze



43PLO3ARG  
Argile



43PLO3AO  
Argent Opaque



43PLO3NR  
Noir Mat

Existe aussi en : Noir Brillant / Cadre Chromé : 43PY03NLC  
Noir Brillant : 43PY03NL

# LINA

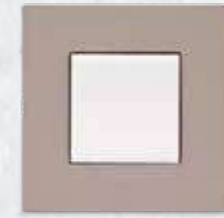

43PL32GRE  
Grège



43PL32TNM  
Titanium



43PL32BRO  
Bronze

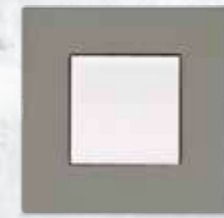

43PL32ARG  
Argile



43PL32AO  
Argent Opaque



43PL32NR  
Noir Mat

# LUMINA 2D

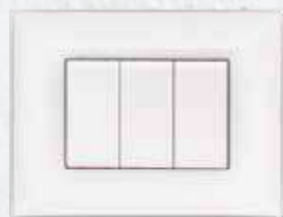

43PLO3B  
Blanc



43PLO3G  
Gris



43PLO3BE  
Beige



43PLO3M  
Marron

# LINA 2D

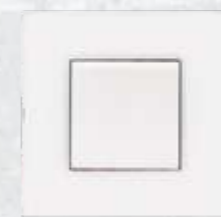

43PL32B  
Blanc



43PL32G  
Gris



43PL32BE  
Beige



43PL32M  
Marron

Toutes les plaques LUMINA et LUMINA 2D rectangulaires existent en version : 3, 4 et 7 modules

Toutes les plaques LINA et LINA 2D carrées existent en version : 2, 2+2 et 2+2+2 modules

Plaque  
**SERENA**  
Rectangulaire  
Système **43**

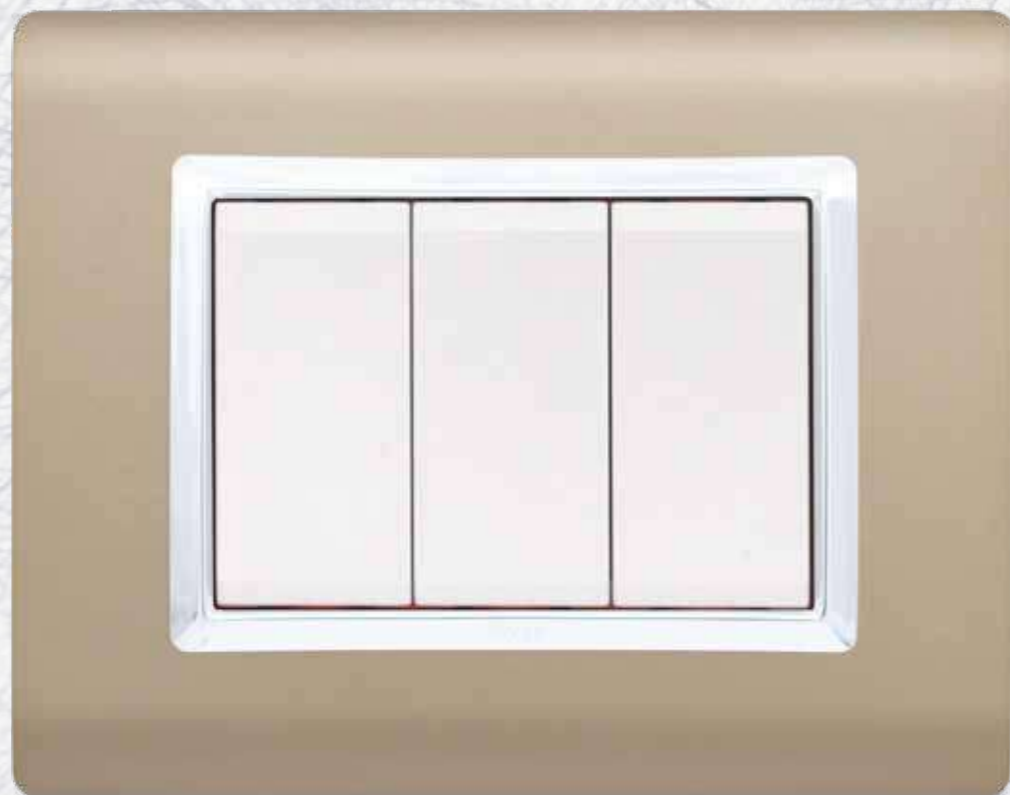

Techno-Basic  
Technopolymère



Wood  
Effet bois



Métal-Elite  
Effet métal

# Techno-Basic

## Technopolymère

Un matériau simple et résistant auquel SOMEF a associé des teintes élégantes et sobres, comme le noir ou le blanc, pour créer des combinaisons ne craignant pas les modes éphémères.

Plaque  
**SERENA**  
Rectangulaire  
Système **43**

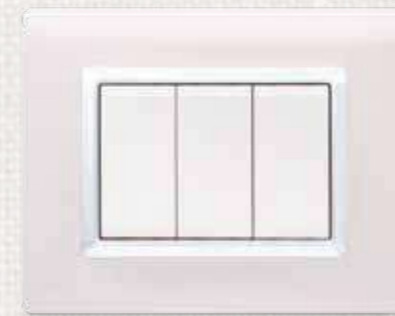

43PLS03BBC  
Blanc / Cadre Chromé

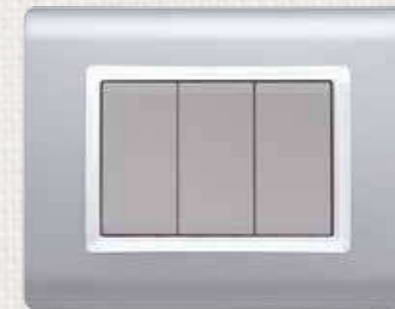

43PLS03AO  
Argent Opaque



43PLS03NMC  
Noir Mat / Cadre Chromé

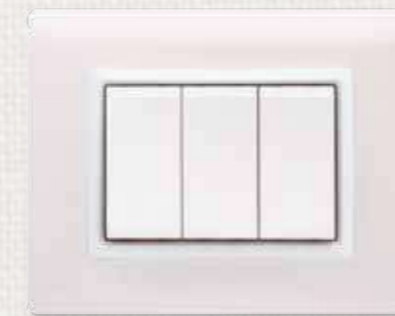

43PLS03BB  
Blanc



43PLS03AOC  
Argent Opaque / Cadre Chromé

## Matériaux et finitions

Une plaque pour chaque ambiance

Des matériaux sélectionnés pour durer, des processus de production novateurs et des finitions dignes du meilleur style italien. Un mariage parfait pour un produit dont le résultat esthétique saura mettre en valeur la personnalité de votre intérieur.

# Métal-Elite

## Effet métal



Un traitement spécial pour un effet métal très flatteur. La forte identité de l'effet métallique offre un mariage inédit pour valoriser les ambiances déclinées dans des tons naturels et chaleureux.

Plaque  
**SERENA**  
Rectangulaire  
Système **43**



43PLS03OTC  
Or Byzantin / Cadre Chromé



43PLS03ROC  
Rose Métallisé / Cadre Chromé



43PLS03CHC  
Champagne / Cadre Chromé

# Wood

## Effet bois

Moderne et raffiné, l'effet bois met en évidence le goût contemporain de la plaque **SERENA**. Trois effets qui mettent la matière en valeur.



Plaque  
**SERENA**  
Rectangulaire  
Système **43**

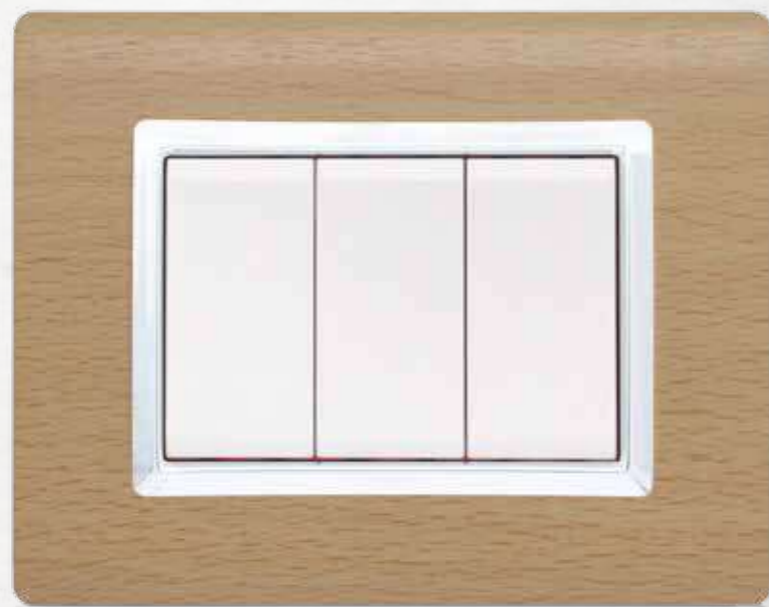

43PLS03WFC  
Wengé / Cadre Chromé



43PLS03WCC  
Chêne / Cadre Chromé



43PLS03WRC  
Acajou / Cadre Chromé

# SERENA Rectangulaire

Techno-Basic  
Technopolymère



43PLS03BBC  
Blanc / Cadre Chromé



43PLS03AOC  
Argent Opaque / Cadre Chromé



Clara Sylvia Nera



43PLS03BB  
Blanc



43PLS03AO  
Argent Opaque



43PLS03NMC  
Noir Mat / Cadre Chromé

Wood  
Effet bois



43PLS03WCC  
Chêne / Cadre Chromé



43PLS03WFC  
Wengé / Cadre Chromé



43PLS03WRC  
Acajou / Cadre Chromé

Métal-Elite  
Effet métal



43PLS03CHC  
Champagne / Cadre Chromé

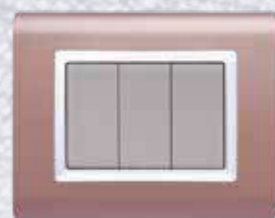

43PLS03ROC  
Rose Métallisé / Cadre Chromé



43PLS03OTC  
Or Byzantin / Cadre Chromé

Toutes les plaques SERENA rectangulaires existent en version : 3, 4 et 7 modules

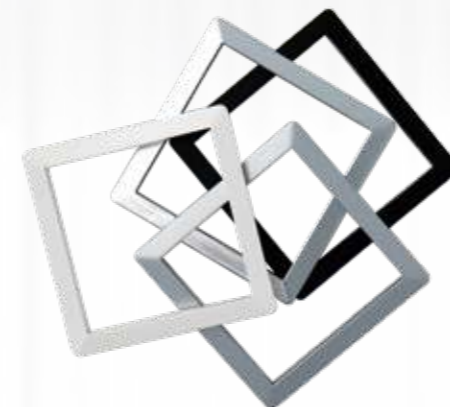

*new*

CADRES  
INTERCHANGEABLES

Plaque  
**SERENA**  
Carrée  
Système **43**



Techno-Basic  
Technopolymère



Métal-Elite  
Effet métal



Wood  
Effet bois

# Techno-Basic Technopolymère

Un matériau simple et résistant auquel SOMEF a associé des teintes élégantes et sobres, comme le noir ou le blanc, pour créer des combinaisons ne craignant pas les modes éphémères.

Plaque  
**SERENA**  
Carrée  
Système **43**



## CADRES INTERCHANGEABLES

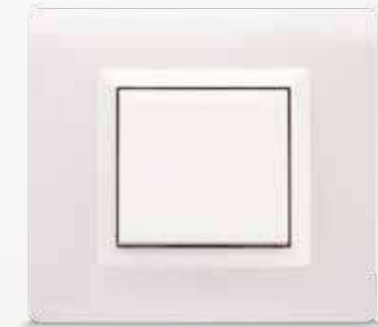
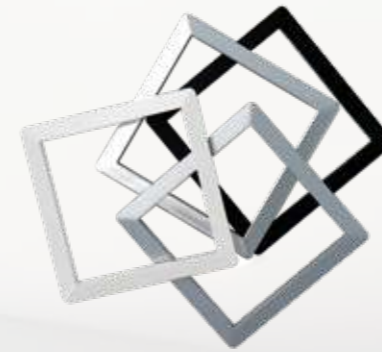

43PLS32B  
Blanc



43PLS32AO  
Argent



43PLS32NM  
Noir Mat

## Matériaux et finitions

Une plaque pour chaque ambiance

Des matériaux sélectionnés pour durer, des processus de production novateurs et des finitions dignes du meilleur style italien. Un mariage parfait pour un produit dont le résultat esthétique saura mettre en valeur la personnalité de votre intérieur.

CADRES  
INTERCHANGEABLES

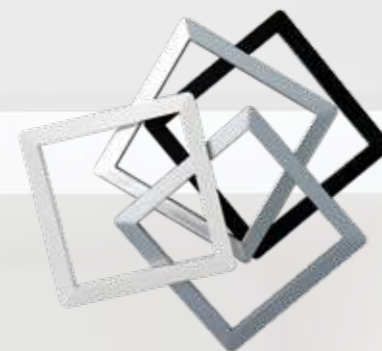

Métal-Elite  
Effet métal



Un traitement spécial pour un effet métal très flatteur. La forte identité de l'effet métallique offre un mariage inédit pour valoriser les ambiances déclinées dans des tons naturels et chaleureux.

Plaque  
**SERENA**  
Carrée  
Système **43**



43PLS32CHO  
Champagne



43PLS32RO  
Rose Métallisé



43PLS32OT  
Or Byzantin





# Wood

## Effet bois

Moderne et raffiné, l'effet bois met en évidence le goût contemporain de la plaque **SERENA**. Trois effets qui mettent la matière en valeur.

### CADRES INTERCHANGEABLES

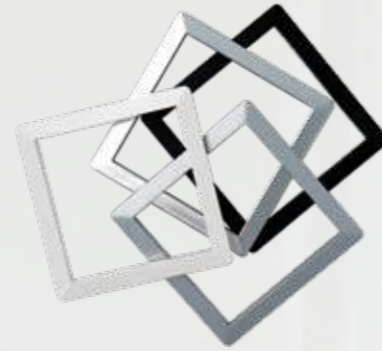

Plaque  
**SERENA**  
Carrée  
Système **43**



43PLS32WC  
Chêne



43PLS03WF  
Wengé



43PLS32WR  
Acajou

PERSONNALISATION PARFAITE

Techno-Basic

Technopolymère

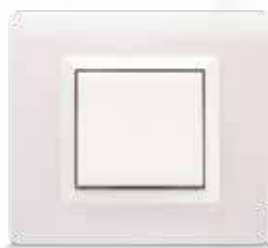

43PLS32B  
Blanc



43PLS32AO  
Argent Opaque



43PLS32NM  
Noir Mat

Wood

Effet bois



43PLS32WC  
Chêne



43PLS32WR  
Acajou



43PLS32WF  
Wengé

Métal-Elite

Effet métal



43PLS32CHO  
Champagne



43PLS32RO  
Rose Métallisé



43PLS32OT  
Or Byzantin

Cadres  
Interchangeables

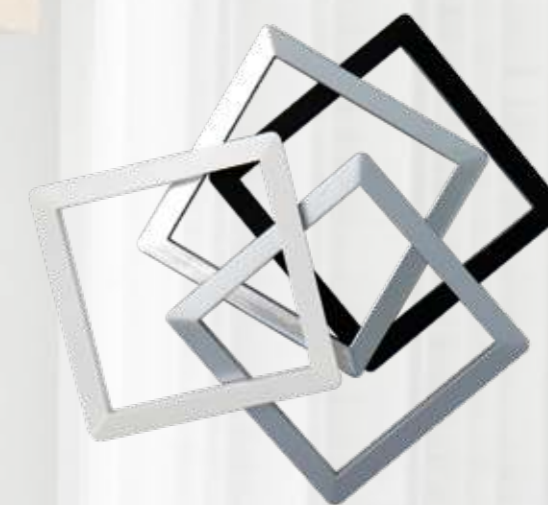

SERENA Carrée offre une flexibilité ultime grâce à ses cadres interchangeables, vous permettant de créer la combinaison parfaite pour chaque espace. Associez les cadres à vos plaques et appareillages pour une harmonie visuelle incomparable. Jouez avec les possibilités infinies pour trouver l'association idéale qui reflète votre style et votre esthétique.

Plaque  
**BELLA**  
Système **43**

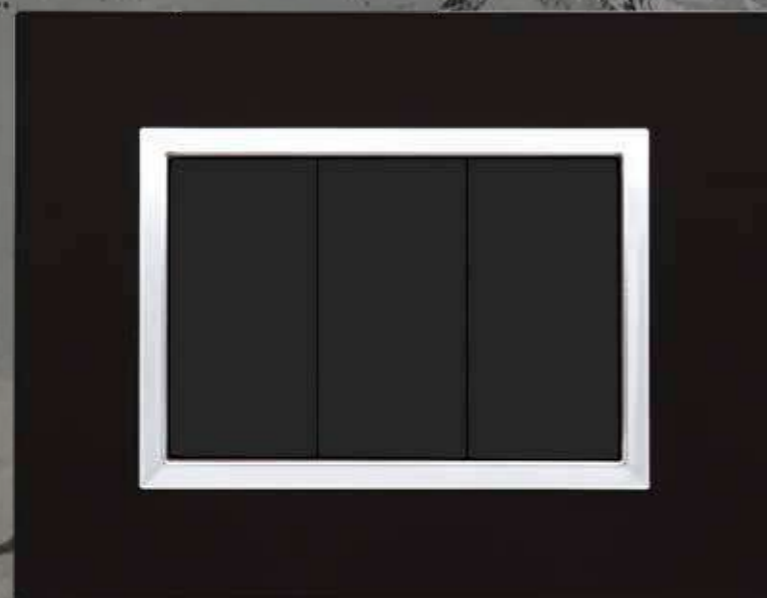

*L'innovation,  
notre promesse !*

Plaque  
**BELLA**  
Système 43

Le design de la plaque **BELLA Rectangulaire** est régulier, avec des angles nets et un profil linéaire. Cette esthétique rigoureuse est déclinée en plusieurs couleurs.

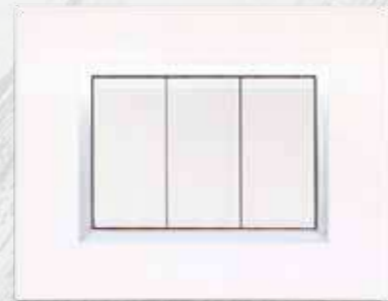

43PY03BLC  
Blanc / Cadre Chromé

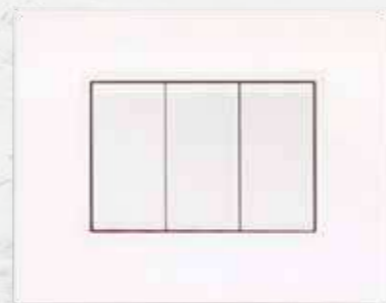

43PY03B  
Blanc



43PY03CHC  
Champagne / Cadre Chromé

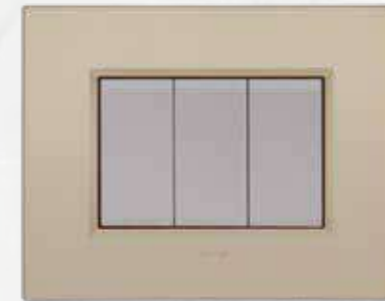

43PY03CHO  
Champagne

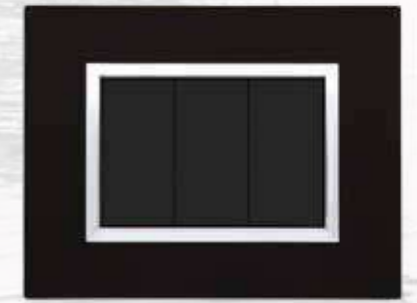

43PY03NRC  
Noir Mat / Cadre Chromé



43PY03NR  
Noir Mat

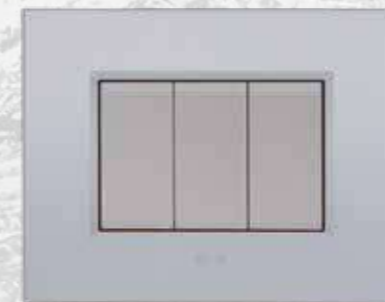

43PY03AO  
Argent Opaque

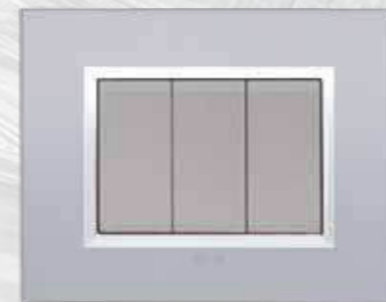

43PY03AOC  
Argent Opaque / Cadre Chromé

Plaque  
**BELLA**  
Système **43**

Elle existe aussi en version **carrée**, en plusieurs couleurs, avec un cadre simple ou chromé.



43P32CHC  
Champagne / Cadre Chromé



43P32CHO  
Champagne

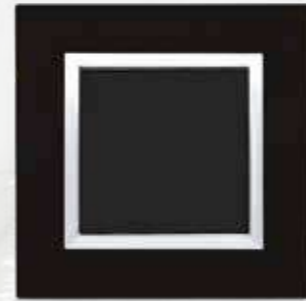

43P32NRC  
Noir Mat / Cadre Chromé

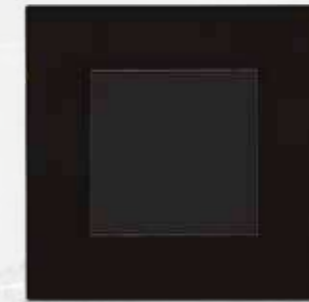

43P32NR  
Noir Mat

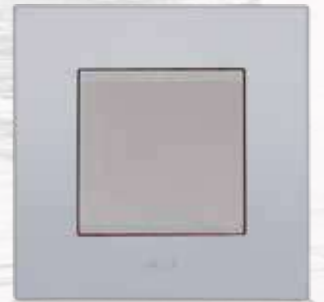

43P32AO  
Argent Opaque

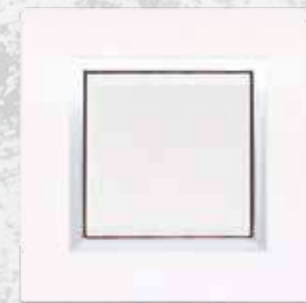

43P32BLC  
Blanc / Cadre Chromé



43P32AOC  
Argent Opaque / Cadre Chromé

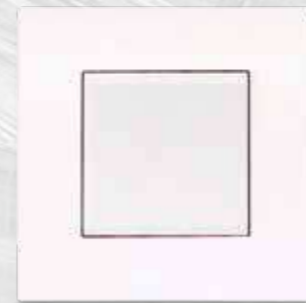

43P32B  
Blanc

# BELLA

Rectangulaire

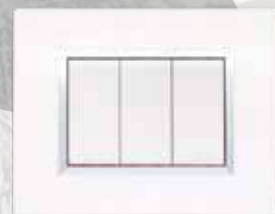

43PY03BLC  
Blanc / Cadre Chromé



43PY03CHC  
Champagne / Cadre Chromé

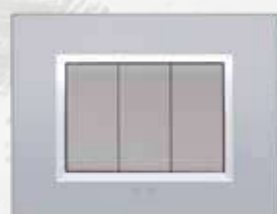

43PY03AOC  
Argent Opaque / Cadre Chromé



43PY03NRC  
Noir Mat / Cadre Chromé

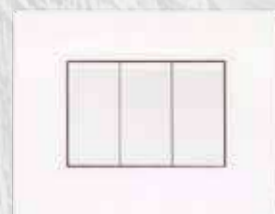

43PY03B  
Blanc



43PY03CHO  
Champagne

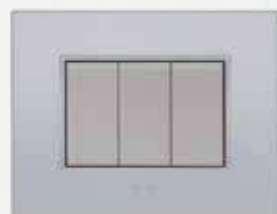

43PY03AO  
Argent Opaque



43PY03NR  
Noir Mat

Existe aussi en : Noir Brillant / Cadre Chromé : 43PY03NLC  
Noir Brillant : 43PY03NL

Toutes les plaques BELLA rectangulaires existent en version : 1, 2, 3, 4 et 7 modules

# BELLA

Carrée

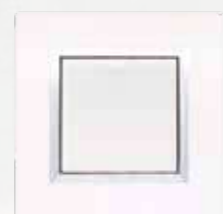

43P32BLC  
Blanc / Cadre Chromé



43P32CHC  
Champagne / Cadre Chromé



43P32AOC  
Argent Opaque / Cadre Chromé

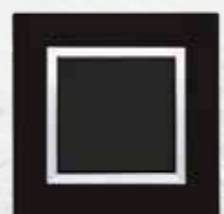

43P32NRC  
Noir Mat / Cadre Chromé



43P32B  
Blanc



43P32CHO  
Champagne



43P32AO  
Argent Opaque



43P32NR  
Noir Mat

Existe aussi en : Noir Brillant / Cadre Chromé : 43P32NLC  
Noir Brillant : 43P32NL

Toutes les plaques BELLA carrées existent en version : 1, 2, 2+2, 2+2+2 et 2+2+2+2 modules

## > Plaques & Cadres

### Plaques pour boîtes rectangulaires



Plaques 1 module  
43PY01B



Plaques 1 module  
43PY01BLC



Plaques 2 modules  
43PY02B



Plaques 3 modules  
43PY03B



Plaques 4 modules  
43PY04B



Plaques 7 modules  
43PY07B

### Plaques pour boîtes rondes et carrées



Plaques 1 module  
43P31B



Plaques 1 module  
43P31BLC



Plaques 2 modules  
43P32B



Plaques 2+2 modules  
43P34B

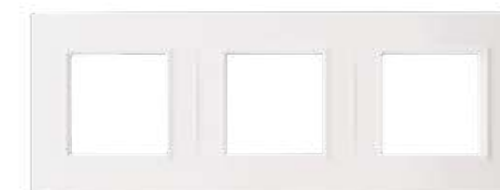

Plaques 2+2+2 modules  
43P36B

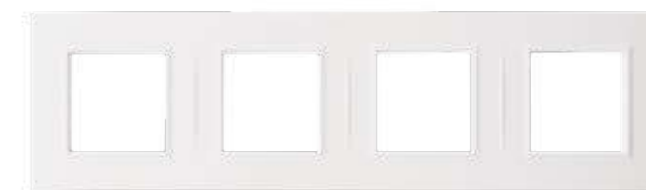

Plaques 2+2+2+2 modules  
43P38B

- Existe en Blanc, Gris, Noir & Champagne  
- Existe avec ou sans Cadre Chromé

> Prises Etanches **IP44\***



Prise étanche 2 modules



Prise étanche 2+2 modules



Prise étanche 2+2+2 modules

\* IP44 :  
 - Protégé contre le corps solide > 1 millimètre.  
 - Protégé contre les petites projections d'eau venant de toutes directions.

> Interrupteurs Etanches

**IP44\***



Interrupteur étanche 2 modules



Interrupteur étanche 2+2 modules



Interrupteur étanche 2+2+2 modules

**Existe en :**

- Simple allumage
- Va et vient
- Bouton poussoir
- Double poussoir
- Bouton à tirette
- Commutateur

\* Toute la gamme existe en version : 2, 2+2 et 2+2+2.  
 Clara, Sylvia et Nera

\* Toute la gamme existe en version : 2, 2+2 et 2+2+2.  
 Clara, Sylvia et Nera

# APPAREILLAGES

Système **43**

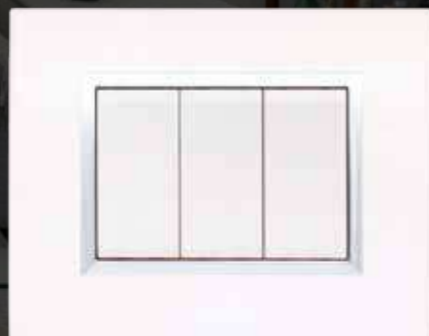

CLARA / Blanc



SYLVIA / Gris

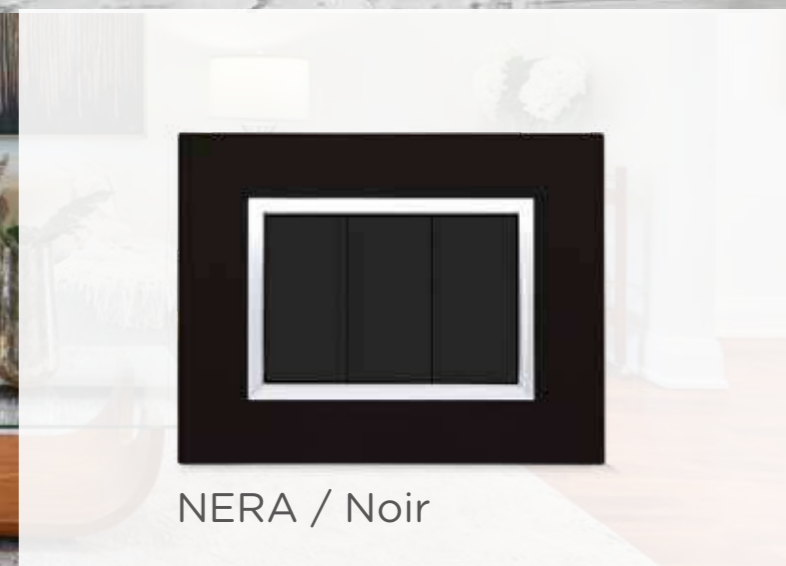

NERA / Noir



## > Appareillages & Caractéristiques Générales :



### ■ Nid d'abeille

Cette nouvelle structure en semi transparent à monter sur la boîte d'encastrement offre une installation facile, rapide et un support robuste.

### Rapide et facile à installer :



**Les fils étant faciles à insérer**, vous connectez et déconnectez les interrupteurs rapidement et sans difficulté.



Les trous d'entrée en entonnoir guident les fils jusqu'à la borne.

### Système d'accrochage Plack-Clack :



L'accrochage Plack-Clack est un système encastrable caractérisé par une grande robustesse structurelle (grâce également à la structure en nid d'abeille du support) et une rigidité exceptionnelle qui permet de brancher et de débrancher plus simplement les appareils de face.

### Fiabilité et robustesse :



**Les plaques de fixation** offrent une excellente résistance à la flexion et à la corrosion.

### La sécurité d'abord :

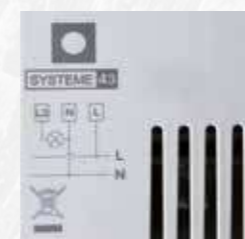

**Le schéma de câblage des fils** vous évite les risques d'erreurs.

### Repiquage simple et facile

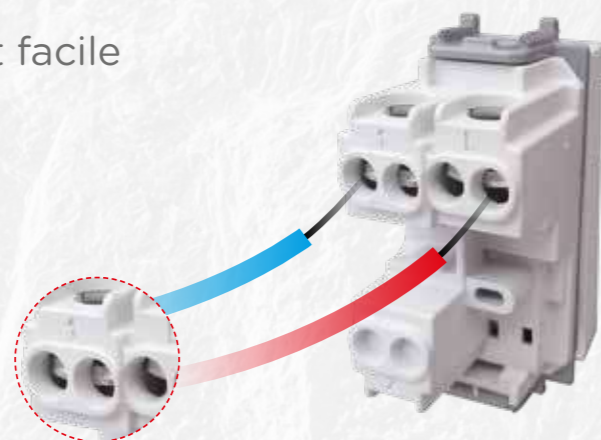

- S'adapte aux câbles de plusieurs sections. De 0,5mm<sup>2</sup> à 2,5mm<sup>2</sup>.

Des encoches pour la fixation du dispositif au support.



Fixation frontale du dispositif au support.

\* Restriction de l'utilisation de certaines substances dangereuses dans les équipements électriques et électroniques.

## Dispositifs de distribution de l'énergie et des données

Somef s'engage depuis des années à créer une symbiose entre l'homme et l'énergie, avec la passion du détail, conformément aux plus hauts critères de qualité, sécurité et longévité. Le résultat est une vaste gamme de prises pour chaque solution, des prises de courant aux prises multimédia et de signal.

### Prises électriques

SOMEF offre une vaste gamme de prises de courant, disposant ainsi des différents standards étrangers, pour répondre aux multiples exigences du marché national et international.



### Prise détrompeur avec obturateur de protection

Prises détrompeur pour distinguer à première vue les lignes dédiées.

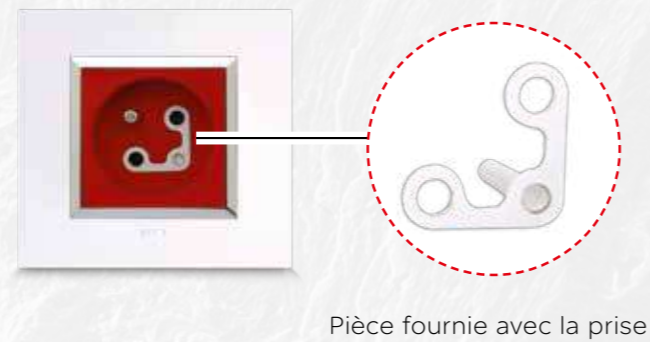

## Chargeurs USB

Ils permettent de recharger rapidement les dispositifs électroniques de notre quotidien : smartphones, tablettes, lecteurs MP3, etc... La prise recharge à grande vitesse les dispositifs les plus puissants.

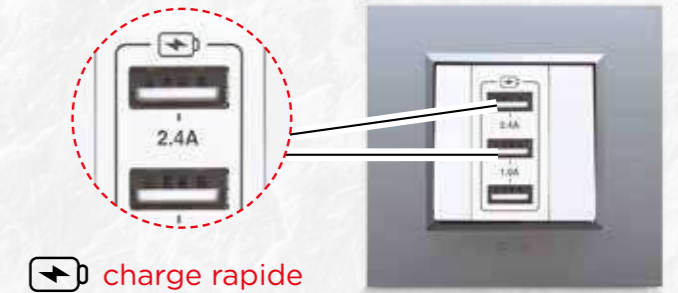

## chargeurs Ultra rapide Type A+C

Pour charger vos smartphones et vos tablettes rapidement

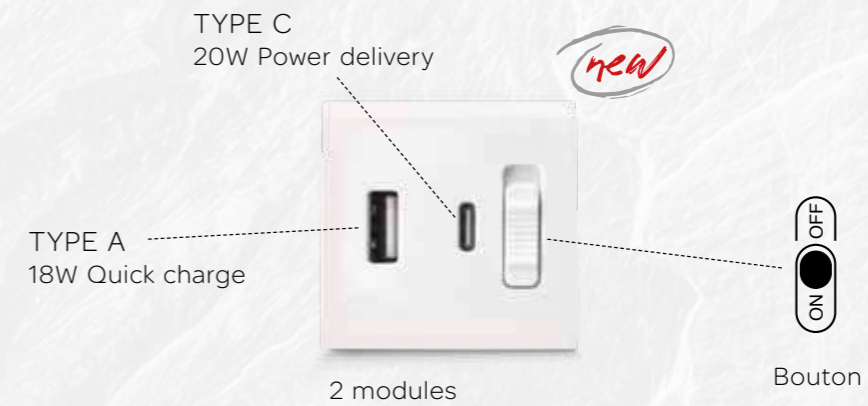

## Prises de signal et multimédia

Elles permettent de connecter les dispositifs électroniques et de transmettre le signal numérique à travers des prises informatiques en cuivre ou fibre optique, téléphoniques de données USB, RCA et TV-FM-SAT. L'assurance d'une connexion fiable et rapide dans le respect des plus hauts critères de qualité.

### Prises TV-FM-SAT

Un seul dispositif regroupant des prises TV, radio et satellite.



### Système de CAP

Le cap remplace les connecteurs à vis. Il offre une solution aussi bien économique que technique pour l'utilisateur final.



Prise SAT type F

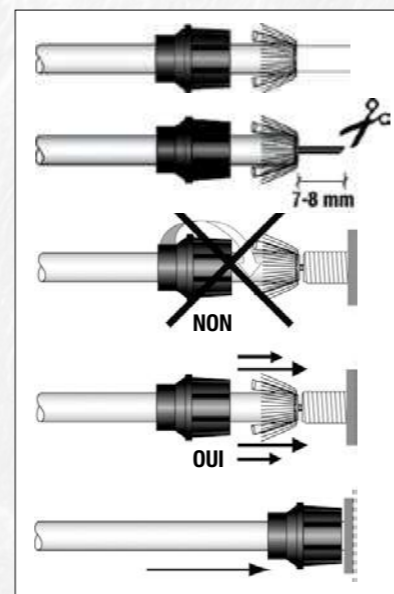

## Prises multimédia

Les prises multimédia vous permettent de relier les différents éléments de vos systèmes informatiques, audio ou vidéo.



Prise HDMI

Prise USB

### Prise HDMI, USB avec cordon & RCA stéréo/vidéo

Le cordon assure une installation facile et rapide à l'intérieur de la boîte d'encastrement.

## Prises Informatiques

Des connexions cat.6 et 6A pour plusieurs types de câblages UTP et STP, pour réseaux en cuivre et fibre optique.



Prise informatique CAT.6A



CAT.6A <math>\left\{ \begin{array}{l} \text{UTP} \\ \text{STP} \end{array} \right.</math>

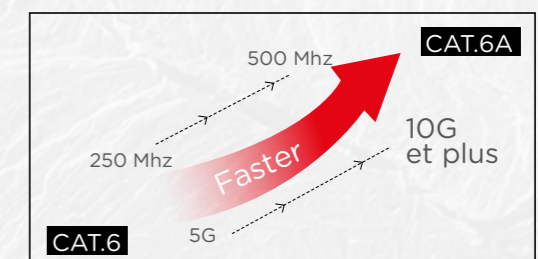

## Prises téléphoniques

Des solutions polyvalentes, simples à installer et assurant d'excellentes performances.

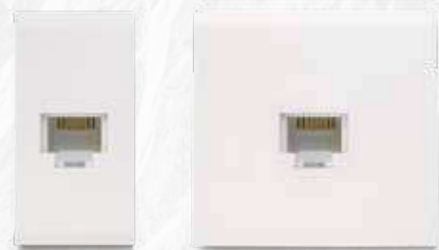

Prise téléphonique

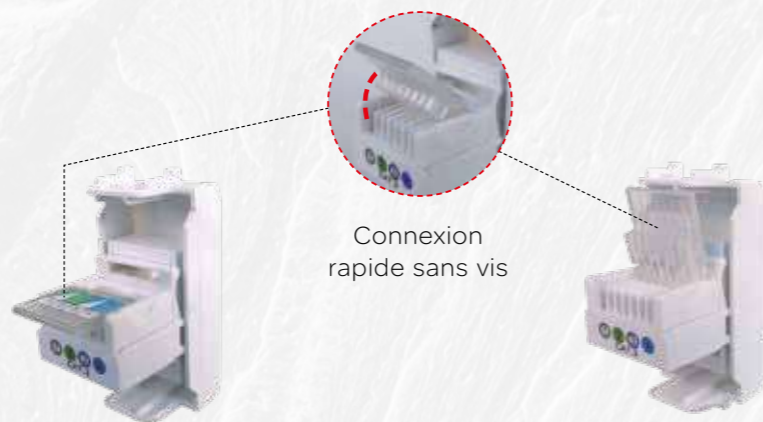

Connexion rapide sans vis

## Prises Sono 2 fils



Prise sono 2 fils

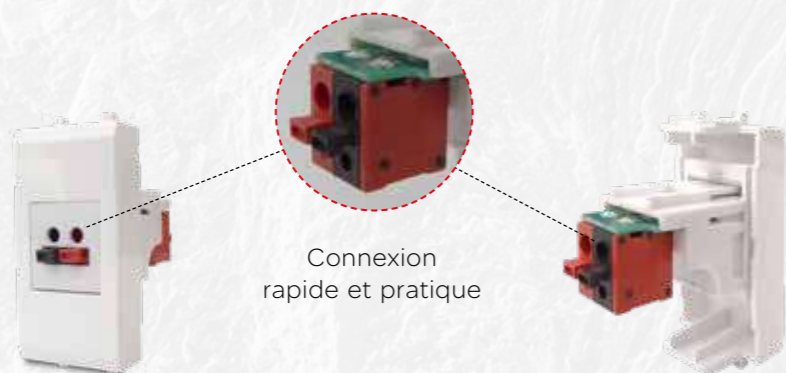

Connexion rapide et pratique

## Récepteur audio bluetooth modulaire

### Gestion du son

Une solution idéale pour votre maison, les établissements hôteliers et tout autre lieu à animer.

- Alimentation de module : 15Vdc 0,8A
- Bluetooth : A2DP / AVRCP
- Distance : 10/12m
- Dimensions : 2 modules
- Alimentation fournie 220v/15Vdc



CLARA  
431048



NERA  
432048



Hauts-parleurs	Puissance
2x4 Ω	2x5 W
4x8 Ω	4x2,5 W
8x16 Ω	8x1,25 W

## STAR Space

STAR Space est la solution audio sur mesure. Elle est évolutive et vous permet de choisir librement vos enceintes et amplificateurs

Le contrôle est géré par l'application KBSOUND® STAR, vous pouvez choisir entre les options de diffusion audio FM, DAB ou Bluetooth

A la maison, dans le bureau, dans les grands surfaces : Conçu pour s'intégrer discrètement

### Contenu du kit :

- Module électronique (Master) avec récepteur Bluetooth, tuner FM/DAB, alimentation et amplificateur audio qui permet de choisir n'importe quel type ou design d'enceinte. Sortie stéréo 10+10W (4y), 5+5W (8y), 2,5+2,5W (16y).
- Connecteur coaxial RF et câble d'antenne pour FM (76 cm).



Hauts-parleurs	Puissance
2x4 Ω	2x10 W
4x8 Ω	4x5 W
8x16 Ω	8x2,5 W

## Dispositifs pour l'efficacité énergétique

### Détecteur de mouvement

C'est un détecteur qui allume la lumière au passage d'une personne à l'intérieur d'une pièce.

- Dimensions : 1 module
- Champ de détection : 120°
- Hauteur d'installation : 1m / 1,7m

Zone de détection

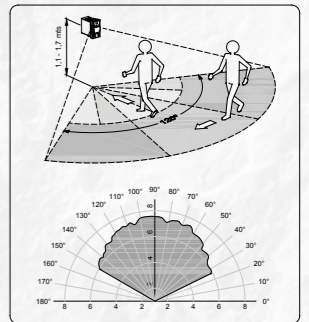

Caractéristiques techniques

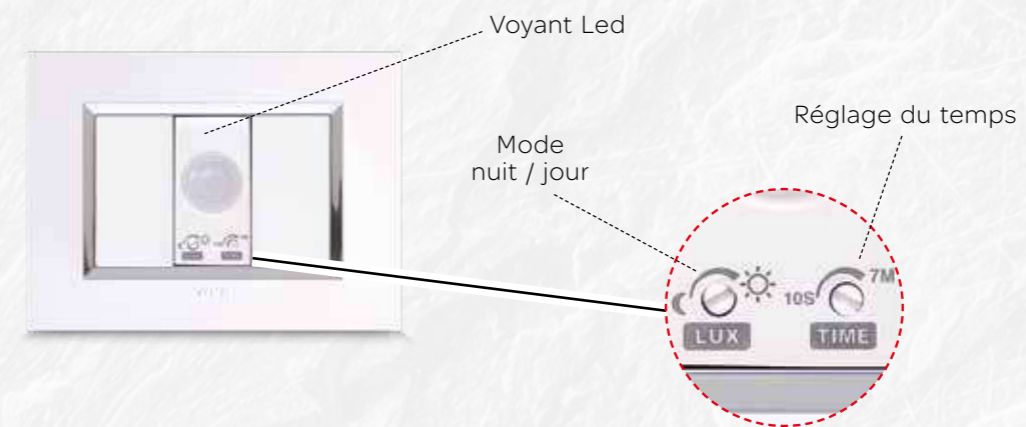
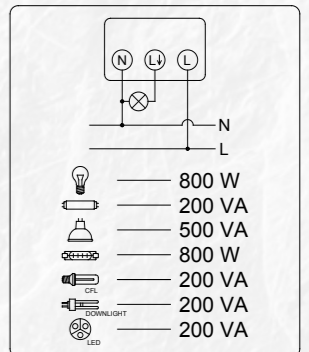

### Lampe de secours

- Lampe de secours non debrochable
- Alimentation : 220V
- Autonomie : >2H
- Dimensions : 1 module



### Ronfleurs

- Ronfleur 220V 1 Module
- Ronfleur 12V 1 Module



### Sonneries

- Sonnerie électronique (carillon)
- Alimentation : 220V 50Hz
- Multitones : 36 mélodies
- Volume : 4 niveaux sonores
- Dimensions : 1 module



## Interrupteurs à carte

L'interrupteur à carte destiné essentiellement aux établissements hôteliers, joue le rôle d'un interrupteur standard, dispose d'un voyant de signalisation, ainsi que de deux contacts séparés : NO, NO/NF.



Blanc

Ivoire

Argent Opaque

Noir Mat

## Montage



2502MG

Mécanisme pour interrupteur à carte

Plaque

Enjoliveur

## Interrupteur à carte temporisé

- Tension nominale d'entrée 100-240V  $\hat{S}$  50/60Hz
- Charge maximale 16A
- Sortie par contact non alimenté (NO ou NF)
- Réglage de temporisation 0<sub>s</sub>-60<sub>s</sub>



431035



433035



432035

## Régulation thermique



Thermostat Rotatif  
2 modules

- Alimentation : 100-240V~ - 50/60Hz
- Charge maximale : 16A (3680W,  $\cos\phi = 1$ )
- Compatible avec tous les types de charges électriques (sortie par contact non alimenté - NO ou NF)
- Contrôle de systèmes : Chauffage et/ ou Refroidissement
- Réglage de la température : 5°C à 30°C
- Différentiel 2°C



Thermostat Multifonctionnel  
2 modules

- Alimentation : 100-240V~ - 50/60Hz
- Charge maximale : 16A (3680W,  $\cos\phi = 1$ )
- Compatible avec tous les types de charges électriques (sortie par contact non alimenté - NO ou NF)
- Contrôle de systèmes : Chauffage et/ ou Refroidissement
- Compatible avec les systèmes électriques et hydrauliques
- Amplitude de lecture de température : -9°C jusqu'à 35°C
- Précision de contrôle de température : 0,5°C





Chronothermostat Multifonctionnel  
2 modules

- Alimentation : 100-240V~ - 50/60Hz
- Charge maximale : 16A (3680W,  $\cos\phi = 1$ )
- Compatible avec tous les types de charges électriques (sortie par contact non alimenté - NO ou NF)
- Contrôle de systèmes : Chauffage et/ ou Refroidissement
- Compatible avec les systèmes électriques et hydrauliques
- Programmation quotidienne / hebdomadaire
- Amplitude de lecture de température : -9°C jusqu'à 35°C
- Précision de contrôle de température : 0,5°C

# Lampe de balisage



Chemin Lumineux :

	 Chaude 2700K	 Neutre 4000K	 Froide 5900K
Clara	<b>431070/2</b>	<b>431071/2</b>	<b>431072/2</b>
Nera	<b>432070/2</b>	<b>432071/2</b>	<b>432072/2</b>
Sylvia	<b>433070/2</b>	<b>433071/2</b>	<b>433072/2</b>

## Caractéristiques

- Tension d'alimentation 230 Vac 50 / 60 Hz
- Montage dans un boîtier de jonction Ø60 ou en surface
- Éclairage direct rasant et frontal
- Éclairage optimal grâce à l'utilisation de diodes électroluminescentes de qualité supérieure
- Couleur d'éclairage stable LED BLANCHE
- Luminosité élevée pour une consommation énergétique minimale
- Source : quatre diodes électroluminescentes (LED)

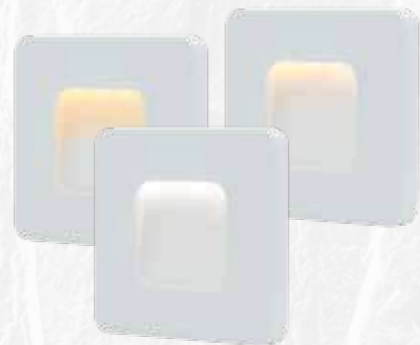
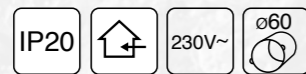

Clara



Nera



Sylvia

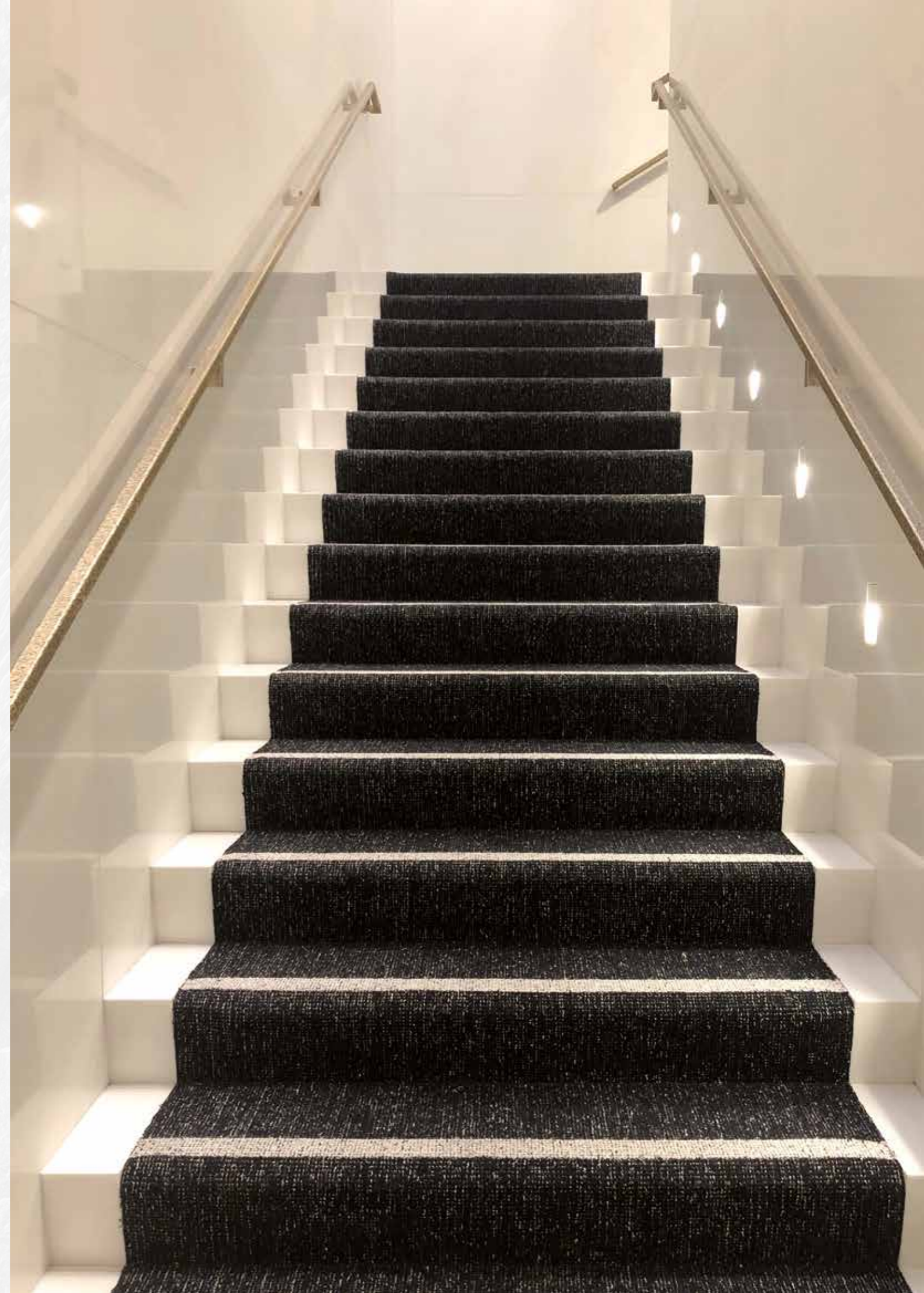

## Schéma d'installation Gamme Carrée

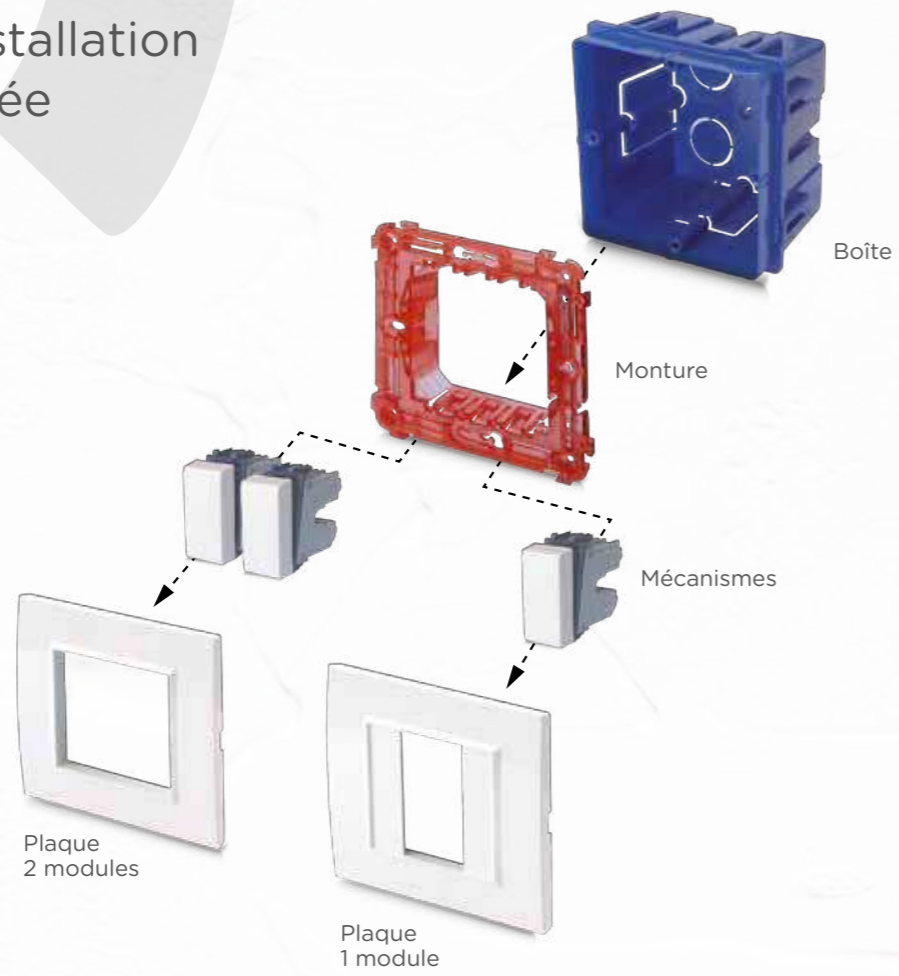

## Schéma d'installation Gamme Rectangulaire

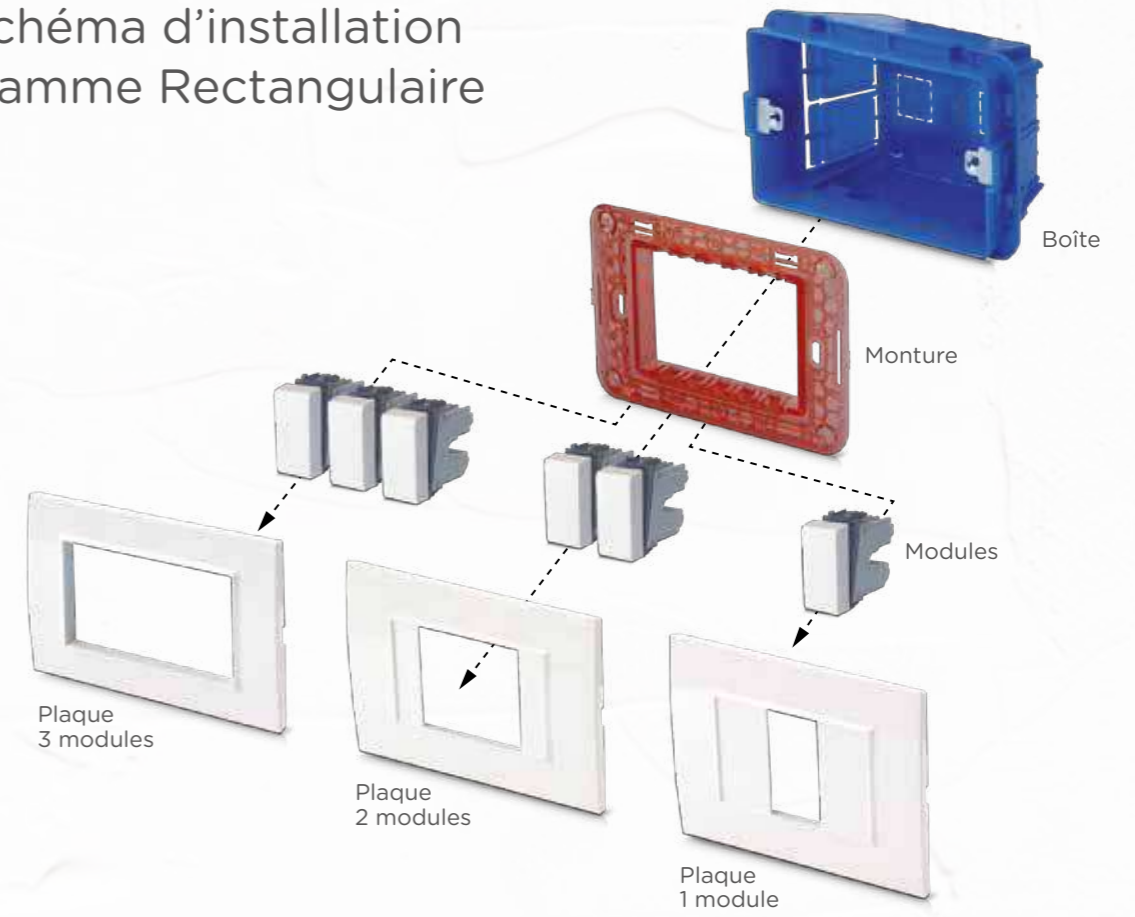

## Installation

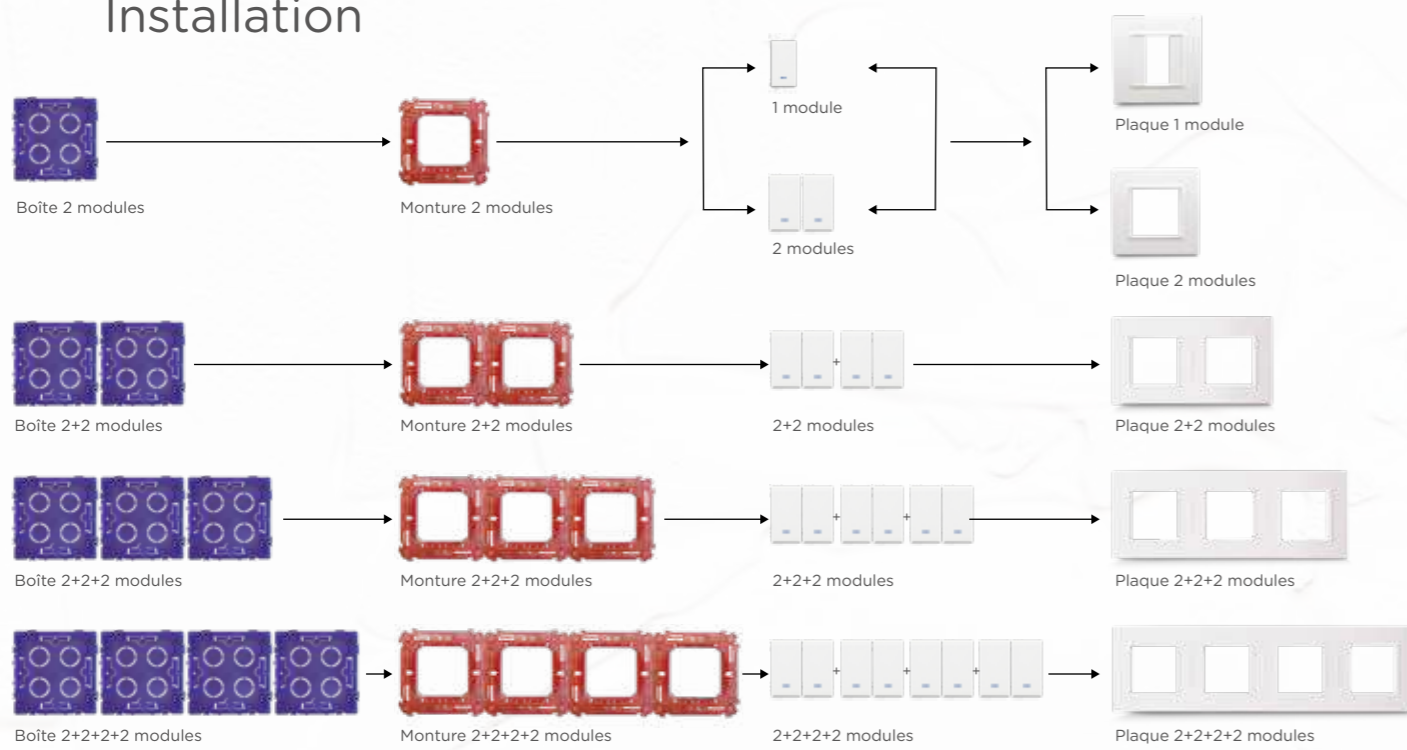

## Installation

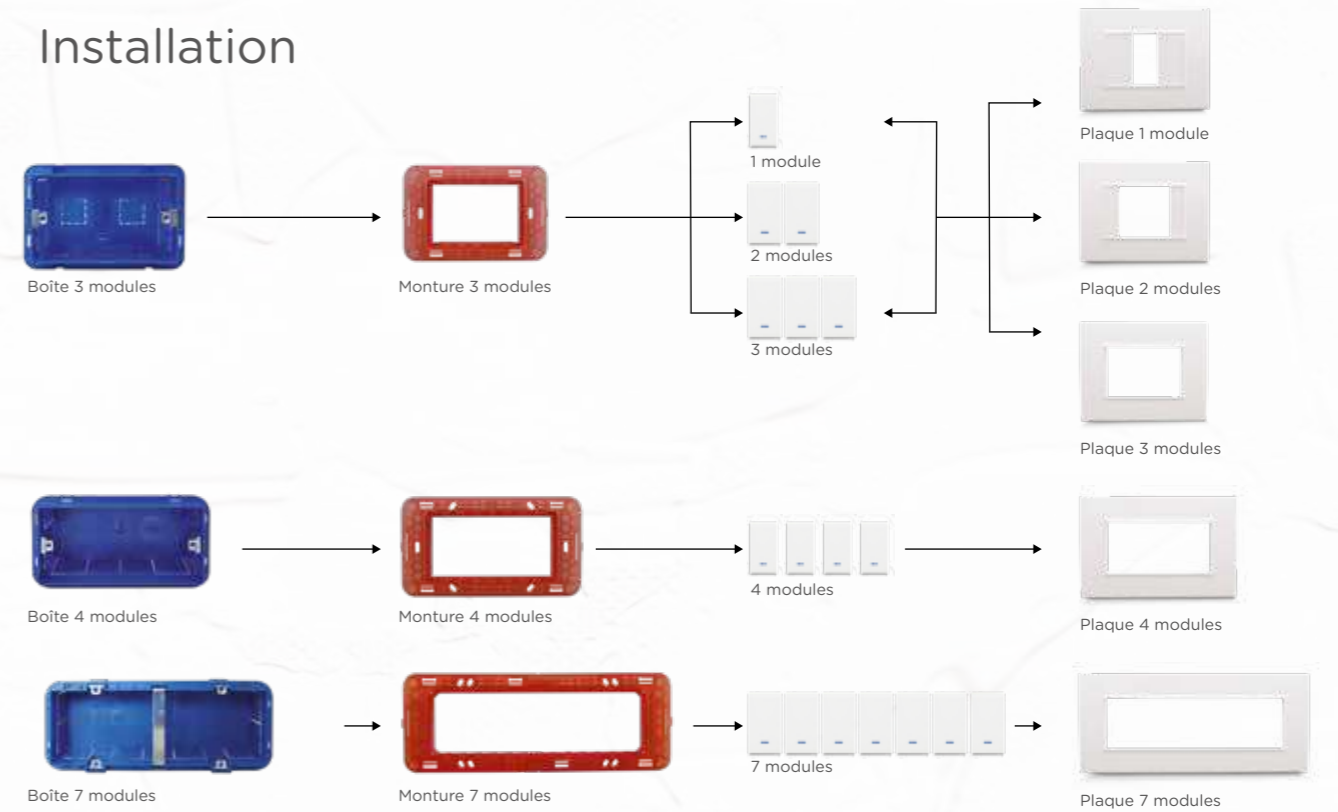



# > Commandes & Accessoires

Clara

Sylvia

Nera

## Interrupteur Simple Allumage 250V - 10A



431001 431001/2

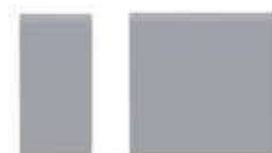

433001 433001/2



432001 432001/2



431001V 431001/2V



433001V 433001/2V



432001V 432001/2V

## Interrupteur Va et Vient 250V - 10A



431002 431002/2

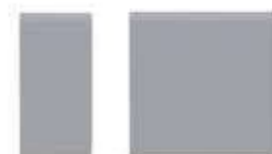

433002 433002/2



432002 432002/2



431002V 431002/2V



433002V 433002/2V



432002V 432002/2V

## Bouton poussoir 250V - 10A



431005 431005/2

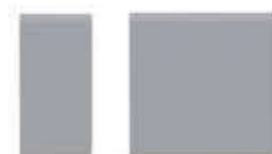

433005 433005/2



432005 432005/2



431005V 431005/2V



433005V 433005/2V



432005V 432005/2V

Clara

Sylvia

Nera

## Interrupteur Bipolaire 250V - 16A



431010 431010/2



433010 433010/2



432010 432010/2



431010V 431010/2V



433010V 433010/2V



432010V 432010/2V

## Interrupteur Inverseur 250V - 16A



431004 431004/2

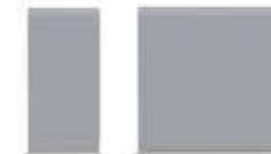

433004 433004/2



432004 432004/2

## Bouche module



431013 Bouche module



431013R 1/2 Bouche module



433013 Bouche module



433013R 1/2 Bouche module



432013 Bouche module



432013R 1/2 Bouche module

## Bouton poussoir à tirette - 10A



431017 Contact NO et/ou NF



433017 Contact NO et/ou NF



432017 Contact NO et/ou NF

## > Commandes & Accessoires

Clara

Sylvia

Nera

### Commande volet roulant 250V - 10A - Commutateur pour volet roulant



431051N / Unipolaire  
431052N / Bipolaire  
Commutateur  
3 positions



431051N/2 / Unipolaire  
431052N/2 / Bipolaire  
Commutateur  
3 positions



433051N / Unipolaire  
433052N / Bipolaire  
Commutateur  
3 positions



433051N/2 / Unipolaire  
433052N/2 / Bipolaire  
Commutateur  
3 positions



432051N / Unipolaire  
432052N / Bipolaire  
Commutateur  
3 positions



432051N/2 / Unipolaire  
432052N/2 / Bipolaire  
Commutateur  
3 positions



431053N / Unipolaire  
431054N / Bipolaire  
Commutateur  
poussoir



431053N/2 / Unipolaire  
431054N/2 / Bipolaire  
Commutateur  
poussoir



433053N / Unipolaire  
433054N / Bipolaire  
Commutateur  
poussoir

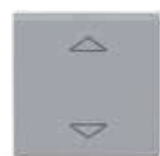

433053N/2 / Unipolaire  
433054N/2 / Bipolaire  
Commutateur  
poussoir



432053N / Unipolaire  
432054N / Bipolaire  
Commutateur  
poussoir



432053N/2 / Unipolaire  
432054N/2 / Bipolaire  
Commutateur  
poussoir

### Prises de courant

#### Prise française (prise 2 pôles +T)



431092TS(16A)  
431092TS20(20A)



433092TS(16A)  
433092TS20(20A)



432092TS(16A)  
432092TS20(20A)

#### Prise standard français (prise 2 pôles)



431034S  
16A



433034S  
16A



432034S  
16A

Clara

Sylvia

Nera

### Prise standard Schuko



431093TS



433093TS



432093TS

### Prise de courant multi-standards



431059TS



433059TS



433059TS

### Prise de courant anglaise (2P+T 13A)



431097TS

#### Prise de courant française 2P+T à détrompage inclinée à 45°



431093TSR

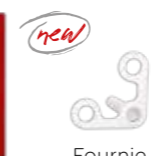

Fournie  
avec la prise

#### Prise française 2P+T - 16A Rouge



431092TSR(16A)

### Prise de courant 2P euro américaine



431033S

### Prise de courant 2 P+T américaine



431035TS

# > Commandes & Accessoires

Clara

Sylvia

Nera

## Prise RCA - Stéréo - Vidéo - 1 module



431046



433046



432046

## Prise SAT et TV



431096F

Prise SAT



431096F/2

Prise SAT



433096F

Prise SAT



433096F/2

Prise SAT



432096F

Prise SAT



432096F/2

Prise SAT



431091K

Prise TV



431091K/2

Prise TV



433091K

Prise TV



433091K/2

Prise TV



432091K

Prise TV



432091K/2

Prise TV

## Prise séparatrice



431096/TRN2

TV/SAT



431096/TRN3

TV/SAT/FM



433096/TRN2

TV/SAT



433096/TRN3

TV/SAT/FM



432096/TRN2

TV/SAT



432096/TRN3

TV/SAT/FM

## Prise Sono



431040R

2 fils



431041R

RCA



433040R

2 fils



433041R

RCA



432040R

2 fils



432041R

RCA

Clara

Sylvia

Nera

## Prise Informatique



431028C6  
431028C6S  
CAT.6



431028C6/2  
431028C6S/2  
CAT.6



433028C6  
433028C6S  
CAT.6



433028C6/2  
433028C6S/2  
CAT.6



432028C6  
432028C6S  
CAT.6



432028C6/2  
432028C6S/2  
CAT.6



431028C6A  
431028C6AS  
CAT.6A



431028C6A/2  
431028C6AS/2  
CAT.6A



433028C6A  
433028C6AS  
CAT.6A



433028C6A/2  
433028C6AS/2  
CAT.6A



432028C6A  
432028C6AS  
CAT.6A



432028C6A/2  
432028C6AS/2  
CAT.6A

## Prise Téléphonique



431024K



431024K/2



433024K



433024K/2



432024K



432024K/2

## Prise HDMI, USB



431042

Prise HDMI



431042/2

Prise HDMI



433042

Prise HDMI



433042/2

Prise HDMI



432042

Prise HDMI



432042/2

Prise HDMI



431043

Prise USB 3.0



431043/2

Prise USB 3.0



433043

Prise USB 3.0



433043/2

Prise USB 3.0



432043

Prise USB 3.0



432043/2

Prise USB 3.0

## > Commandes & Accessoires

Clara

Sylvia

Nera

### Chargeur Ultra-Rapide



**431085USB**  
18W Quick charge  
20W Power delivery

**431086USB**  
18W Quick charge  
20W Power delivery



**433085USB**  
18W Quick charge  
20W Power delivery

**433086USB**  
18W Quick charge  
20W Power delivery



**432085USB**  
18W Quick charge  
20W Power delivery

**432086USB**  
18W Quick charge  
20W Power delivery

### Chargeur USB



**431081USB**  
Chargeur USB  
2,4A

**431084USB**  
Chargeur USB Triple  
3,4A



**433081USB**  
Chargeur USB  
2,4A

**433084USB**  
Chargeur USB Triple  
3,4A



**432081USB**  
Chargeur USB  
2,4A

**432084USB**  
Chargeur USB Triple  
3,4A

### Sonnerie



**431029(220V)**



**433029(220V)**



**432029(220V)**

### Ronfleur

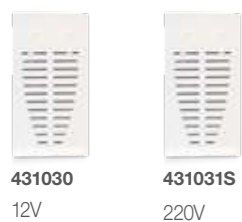

**431030**  
12V

**431031S**  
220V



**433030**  
12V

**433031S**  
220V



**432030**  
12V

**432031S**  
220V

Clara

Sylvia

Nera

### Lampe de secours



**431086S**



**433086S**



**432086S**

### Variateur



**431018**



**433018**



**432018**

### Détecteur de mouvement



**431068S**



**433068S**



**432068S**

### Module Bluetooth pour gestion du son



**431048**



**432048**

# Boîtes Apparentes



**43Q41NR**  
 **43Q41**  
 1 module

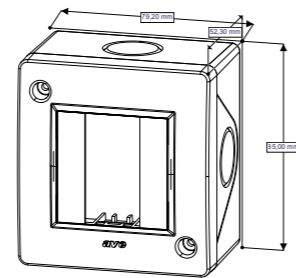

**43Q42NR**  
 **43Q42**  
 2 modules

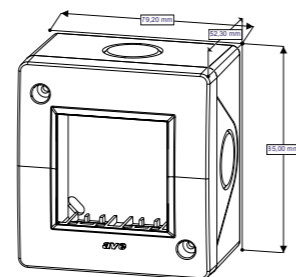

**43Q44NR**  
 **43Q44**  
 4 modules

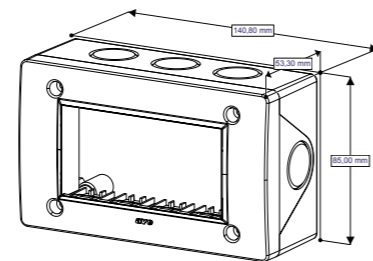

**43Q46NR**  
 **43Q46**  
 6 modules

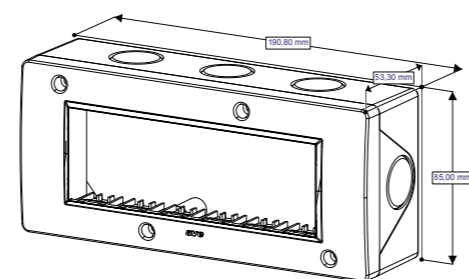

## Notes

---

---

---

---

---

---

---

---

---

---

---

---

---

---

---

---

---

---

---

---

---

---

---

---

Toutes les Boîtes sont disponibles en : Blanc et Noir mat



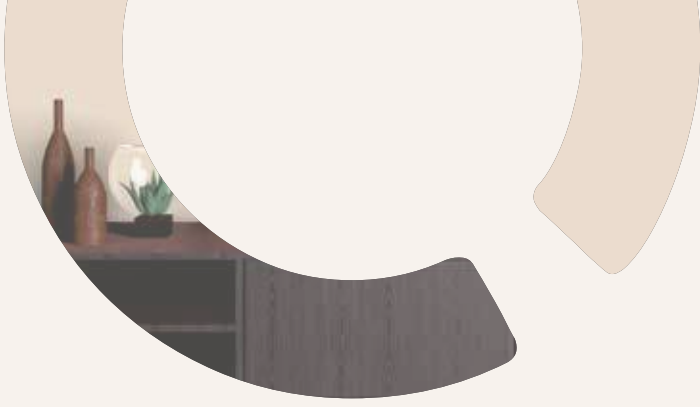

VIDÉOPHONE



APPAREILLAGE



ECONOMIE D'ENERGIE



DOMOTIQUE



INTERPHONE

ECLAIRAGE



DISJONCTEUR

ECONOMIE D'ENERGIE

APPAREILLAGE

ECLAIRAGE

INTERPHONE

DOMOTIQUE

VIDÉOPHONE



DISJONCTEUR



**Siège Tunis** : Rue des Usines Z.I. Sidi Rezig - 2033 Megrine - Tunis - TUNISIE  
Tél.: (+216) 71 429 611 - (+216) 71 429 612 - Fax : (+216) 71 428 562 - Email : info@somef.tn

**Showroom Soukra** : Tél.: (+216) 56 837 444 - Email : showroom.tunis@somef.tn

**Showroom Sfax** : Tél.: (+216) 56 837 454 - Email : showroom.sfax@somef.tn

**Showroom Sousse** : Tél.: (+216) 51 388 737 - Email : showroom.sousse@somef.tn



[www.somef.tn](http://www.somef.tn)